

HEINNER

USER AND INSTALLATION MANUAL FOR WIRELESS CONTROL

Models:

HAC-CR09KITWIFI	HAC-CR18WIFI	HAC-CO12WFN-WH	HAC-MRB12SLWIFI
HAC-CR12WIFI	HAC-CR18KITWIFI	HAC-CO12WFN-RD	HAC-MRB12WHWIFI
HAC-CR12KITWIFI	HAC-CR24WIFI	HAC-CO12WFN-SL	HAC-BP12WIFI-BK
	HAC-CR24KITWIFI	HAC-CO12WFN-GD	HAC-CLS12WHWIFI

I. CAUTIONS AND PRECAUTIONS

DECLARATION OF CONFORMITY

Hereby, we declare that this Smart kit follows the essential requirements and other relevant provisions of Directive 2014/53/EU.

FEATURES

Model: EU-OSK105, US-OSK105

Standard: IEEE 802. 11b/g/n

Antenna type: Printed PCB Antenna

Frequency band: 2400 - 2483.5 MHz

Operation temperature: 0°C~45°C/32°F~113°F

Operation humidity: 10%~85%

Power input: DC 5V/300mA

Maximum TX power: <20dBm

PRECAUTIONS

Applicable operating systems: iOS, Android.

- Please keep the app up to date.
- Given the special situations that may occur, we mention the following: Not all Android and iOS systems are compatible with the app. We do not accept any liability for problems arising from incompatibility.

Wireless security

The Wi-Fi kit only supports WPA-PSK / WPA2-PSK encryption methods and unencrypted networks.

WPA-PSK / WPA2-PSK encryption is recommended.

Cautions

- Due to the different situations that may arise during the use of the network, the control process may encounter problems. In this case, the information in the device and in the app may not be the same.
- The smartphone camera must have a resolution of at least 5 mp for the correct scanning of the QR code.
- Due to the different situations that may exist during network usage, the request timeout may be caused, and the network may need to be reconfigured.
- To improve product features, the app may be updated without prior notice. The actual network setup process may be slightly different from the one in the manual.

II. DOWNLOADING AND INSTALLING THE APP

Caution: The QR code below is only available for app download. This is completely different from the QR code packed with the Wi-Fi kit.



Android



iOS

- Android phone users: scan Android QR code or go to Google Play, search „NetHome Plus” app and download it.
- iOS users: scan iOS QR code or go to APP Store, search „NetHome Plus” app and download it.

III. SMART KIT (WIRELESS MODULE) INSTALLATION

1. Remove the protective cap of the smart kit (wireless module).
2. Open the front panel and insert the smart kit (wireless module) into the reserved interface.
3. Attach the QR code packed with Smart kit (wireless module) to the side panel of the machine, making sure it can be easily scanned with your smartphone. Alternatively, the user can take a picture of the QR code and save it to their phone.

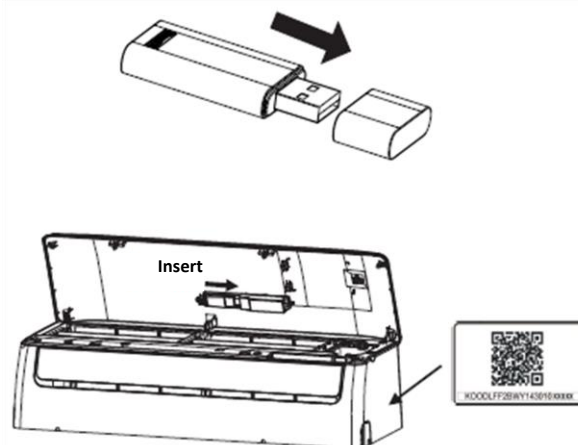

Warning: This interface is only compatible with SMART KIT (wireless module) provided by the manufacturer.

IV. USER REGISTRATION

- Please make sure your mobile device is connected to the Wi-Fi router. The Wi-Fi router must also be connected to the Internet before user registration and network setup.
- We recommend that you log in to the email and activate the registration by accessing the link, in case you forget your password. You can sign in using your account.

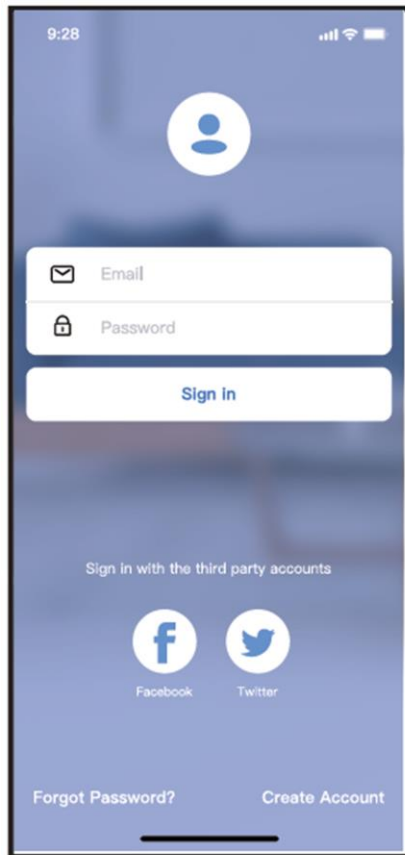

Android

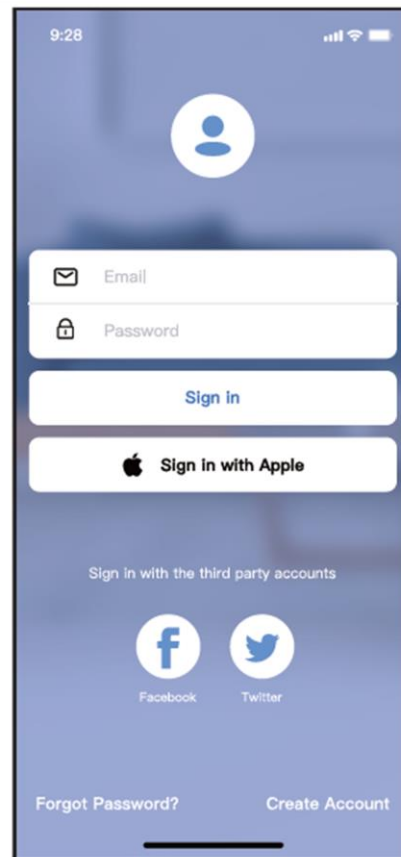

iOS

1. Click “Create account”.

9:41

Create Account

Enter your Email address

Password

Confirm Password

Password need 6–20 characters,must contain letters and numbers.

Register

I have read and agree to the terms and privacy

2. Enter your email address and password, and then click “Register” .

Cautions:

- You need to clear the settings for the other Wi-Fi networks in the area, and make sure your iOS or Android device is connecting to the Wi-Fi network you want to set up.
- Make sure the Wi-Fi feature of your iOS or Android device is active, and that your mobile device can automatically reconnect to the Wi-Fi network.

Please note the following:

The user must complete all the steps within 8 minutes of powering on the air conditioner. Otherwise, the appliance must be powered on again.

Using Android or iOS device to configure the network

- Make sure your mobile device has already been connected to the Wi-Fi network which you want to use. Also, you need to forget other irrelevant Wi-Fi network in case it influences your configuration process.
- Disconnect the power supply of AC.
- Connect the power supply of AC, and continuously press the “LED DISPLAY” or “DO NOT DISTURB” button seven times in 10 seconds.
- When the AC displays “AP”, it means that the AC Wi-Fi has already entered into “AP” mode.

Note:

There are two ways to finish the network configuration:

- Network configuration by Bluetooth scan.
- Network configuration by selecting the device type.

Network configuration by Bluetooth scan

Note: make sure the Bluetooth of your mobile device is working.

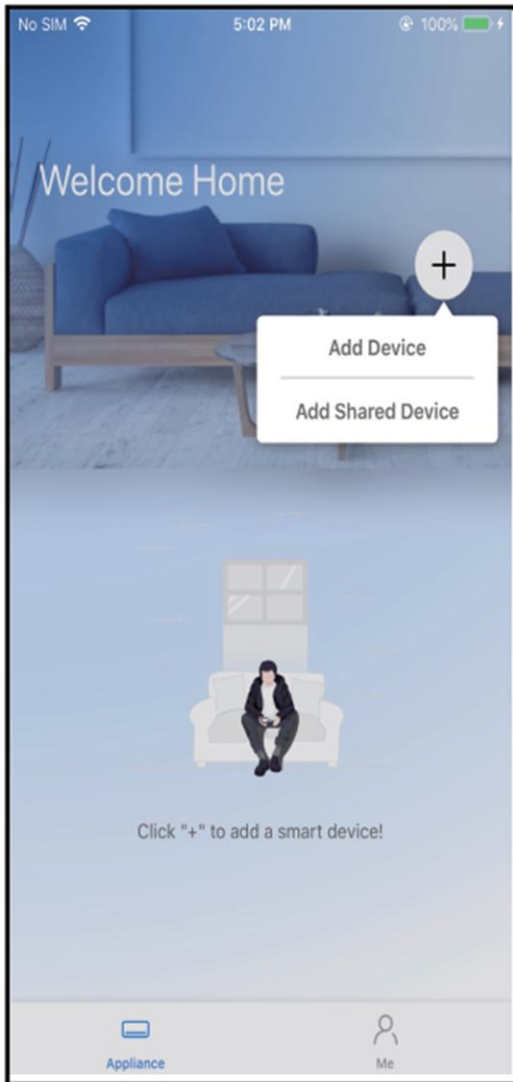

1. Press "+ Add device"

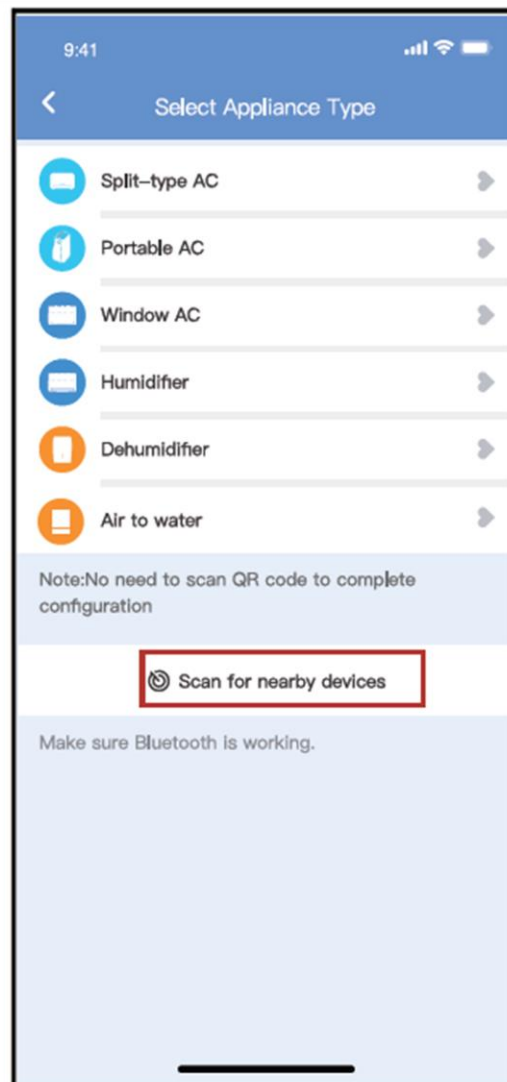

2. Press "Scan for nearby devices"

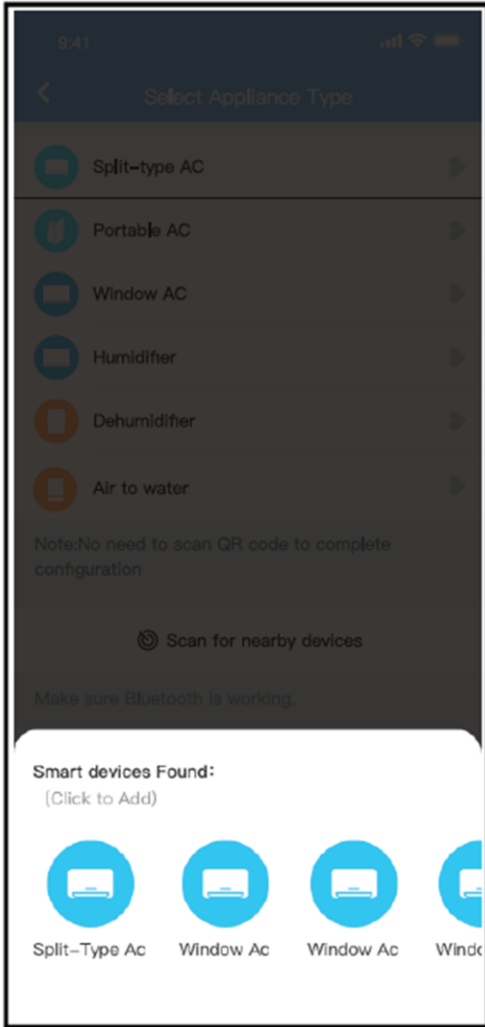

3. Wait until the smart device is found, then touch the icon corresponding to the desired device.

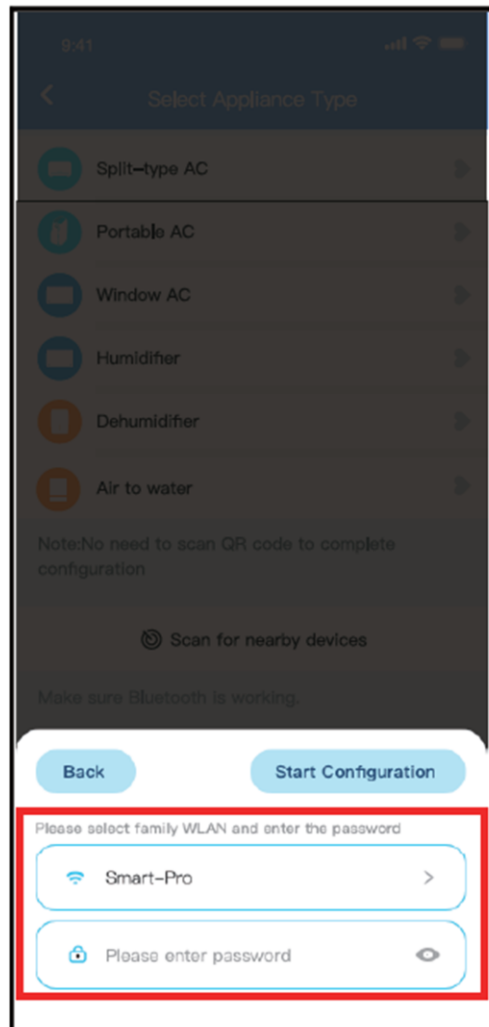

4. Select the Wi-Fi network, then enter the password.

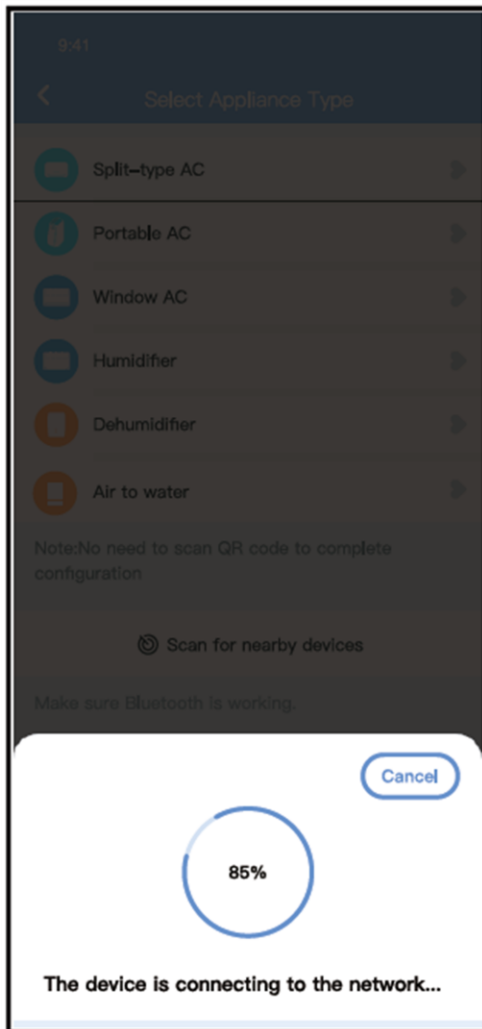

5. Wait until the network connection is complete.

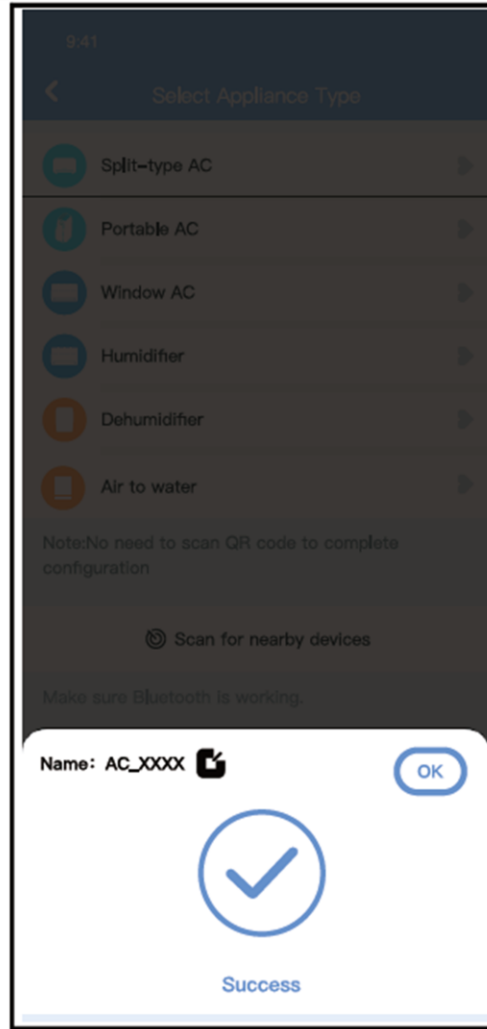

6. The configuration has been completed; you can change the default name.



7. You can select an existing name or a new name.

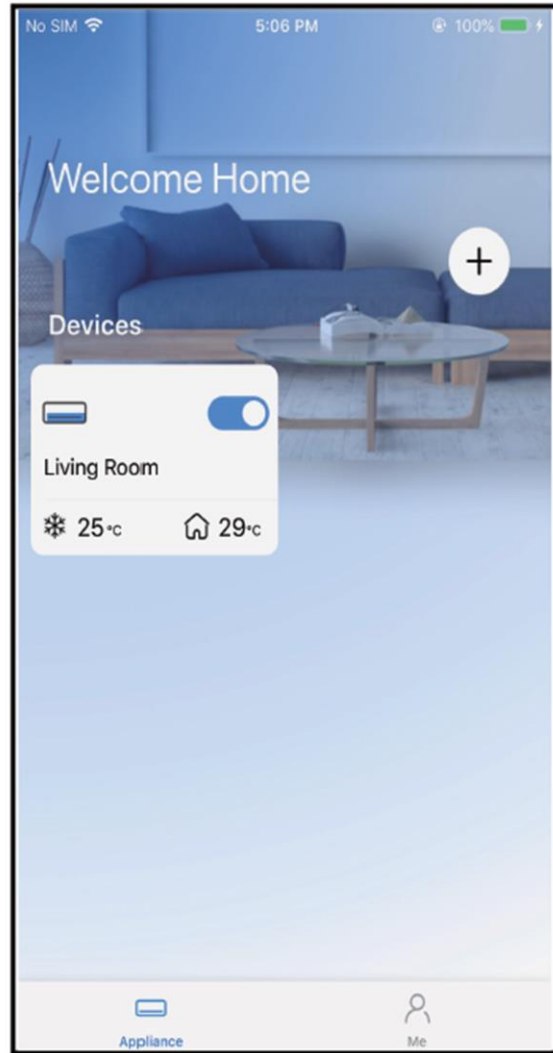

8. Bluetooth network setup has been completed; you can see the device in the list.

Network configuration by selecting the device type

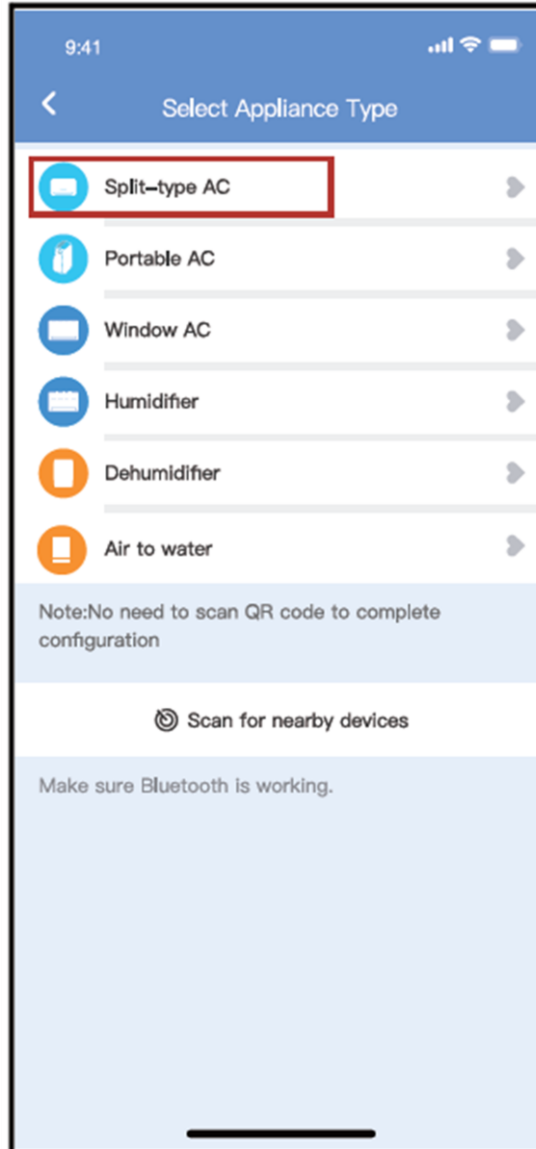

1. If the network setup via Bluetooth is not successful, please select the device type.

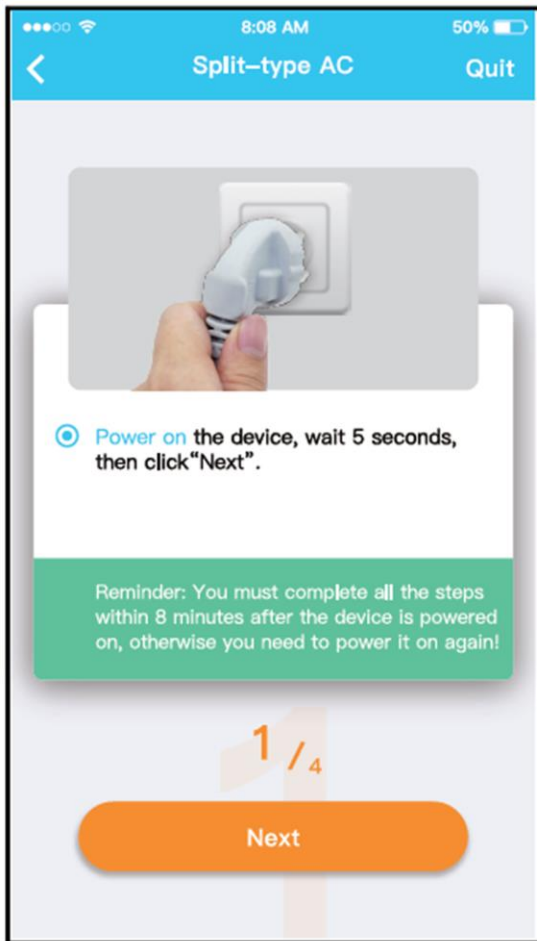

2. Please follow the steps below to activate the "AP" mode.

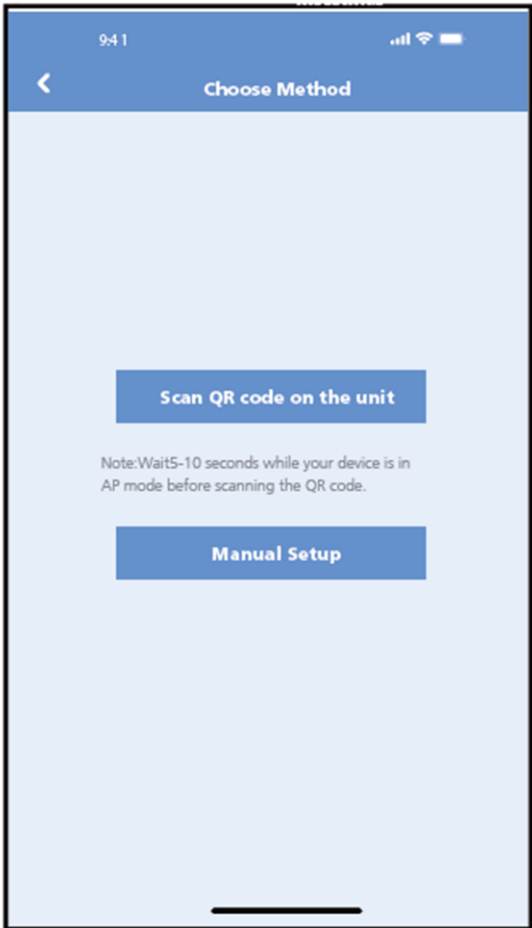

3. Select the network configuration method.

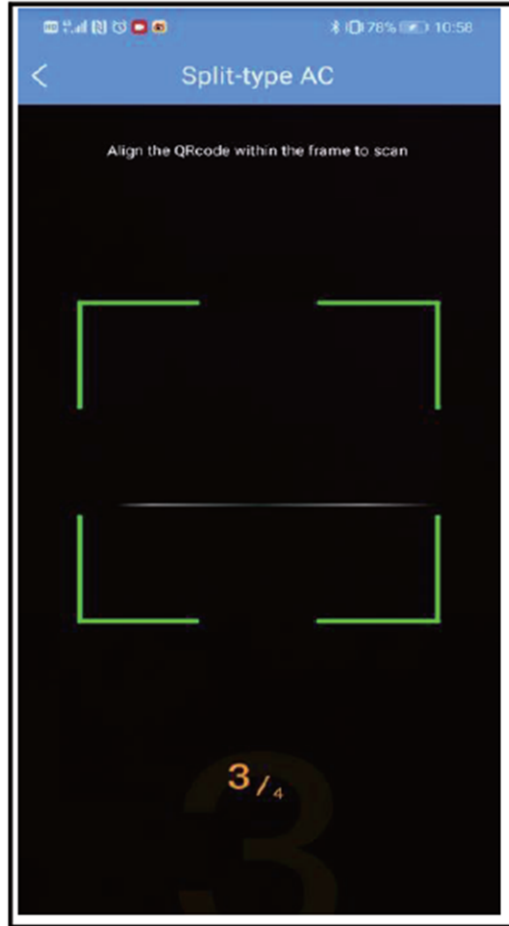

4. Select the "Scan QR code" method.

Note: Steps 3 and 4 are applicable to Android system only. iOS system does not need these two steps.



5. Select the "Manual setup" method (Android). Connect your device to the wireless network (iOS).

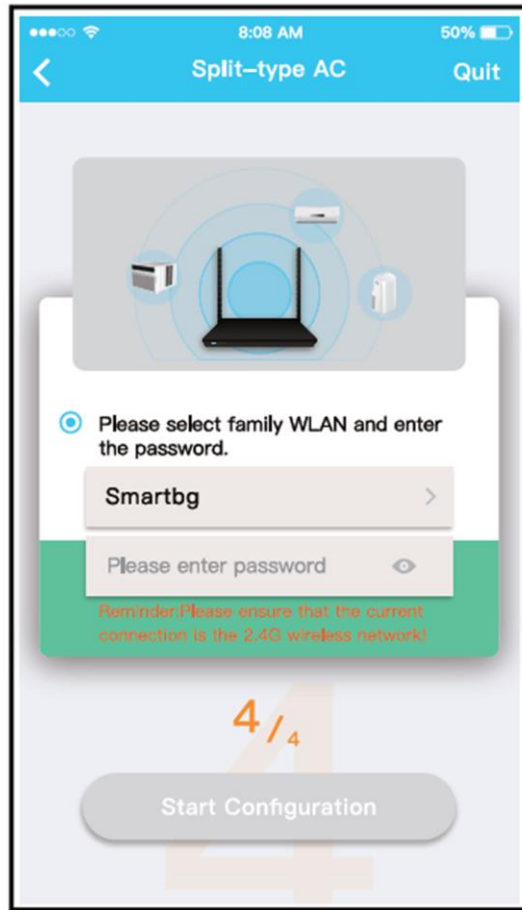

6. Please enter the password.

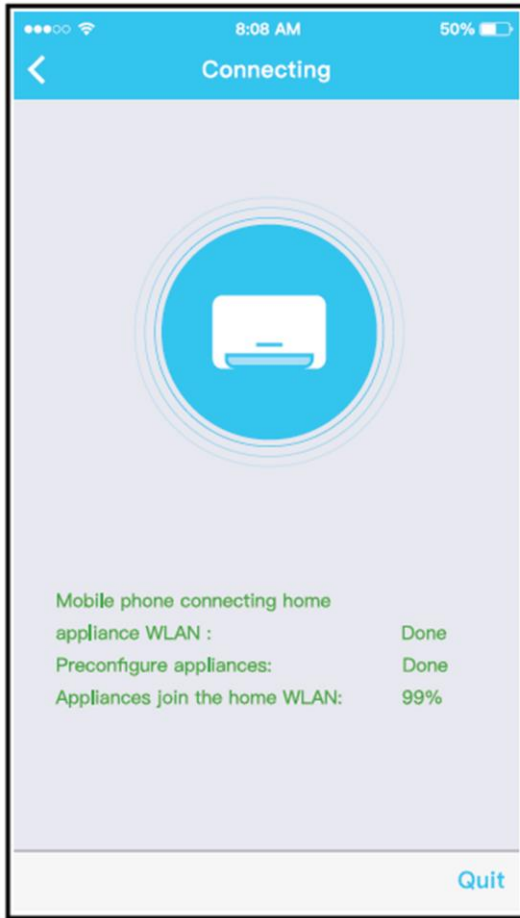

7. Network configuration succeeded.

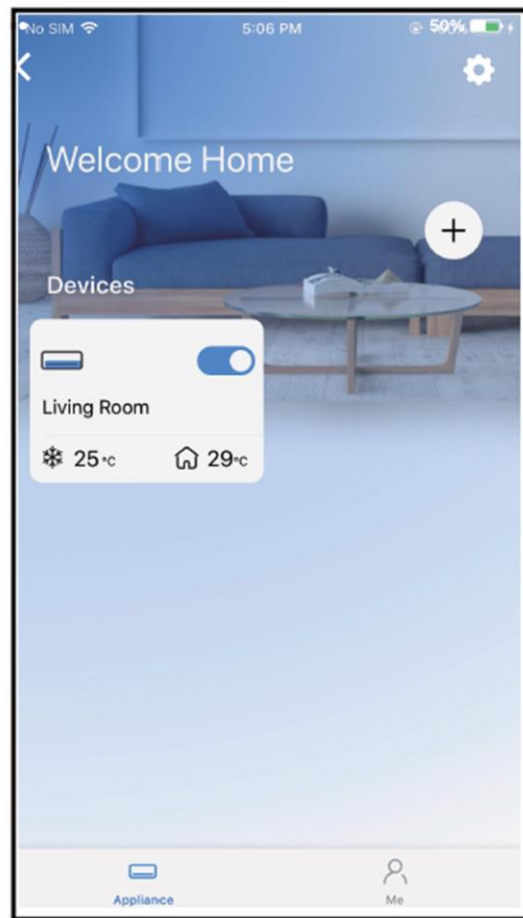

8. Configuration was successful, and the device will be displayed in the list.

Note:

- After completing the network configuration, the app will display configuration confirmation messages on the screen.
- Due to the special situations that may occur while using the Internet connection, the displayed status of the device may be "offline". In this case, you need to refresh the device list in the app and make sure that the device status is online. Alternatively, you can turn off the AC power and turn on it again, and the status of the device will become "online" after a few minutes.

VI. HOW TO USE THE APP

Before using the app for controlling the air conditioner via the Internet, please make sure that the mobile device and the air conditioner are connected to the Internet.

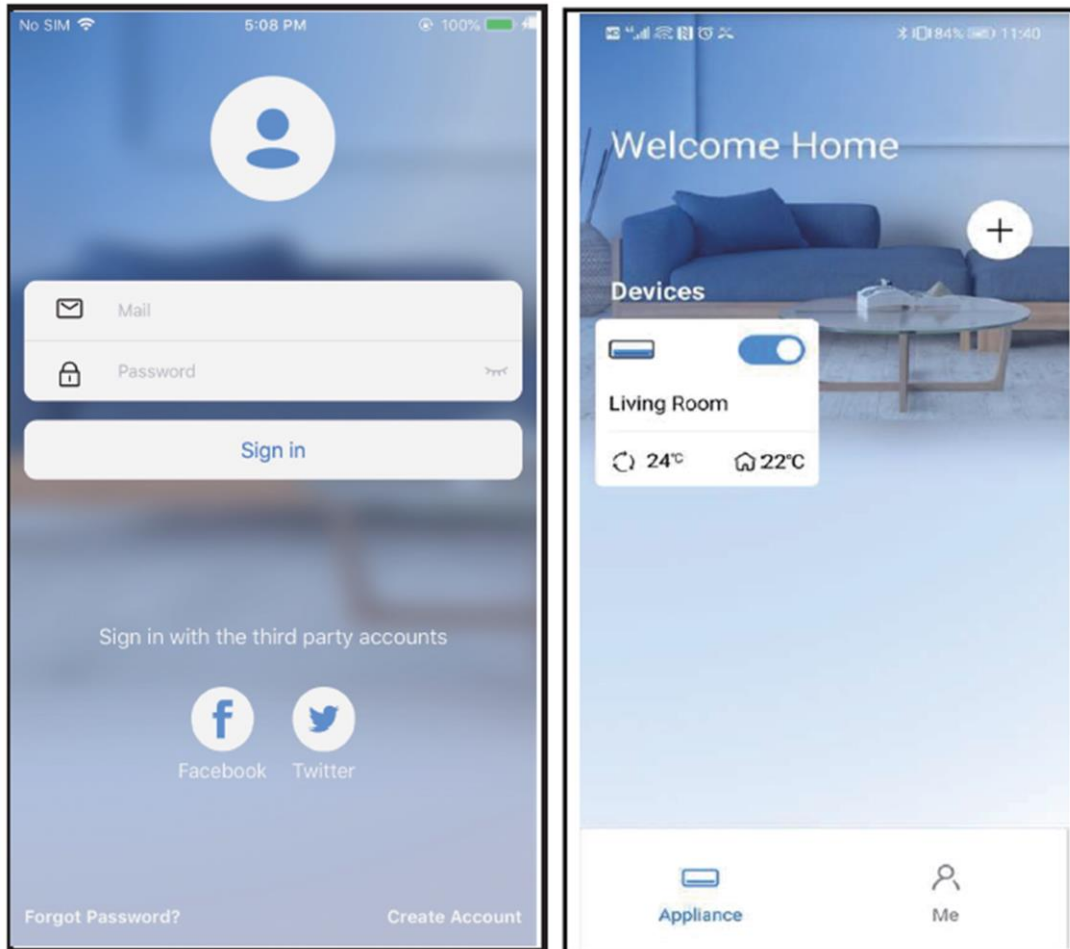

1. Click "Sign in"

2. Select air conditioning unit

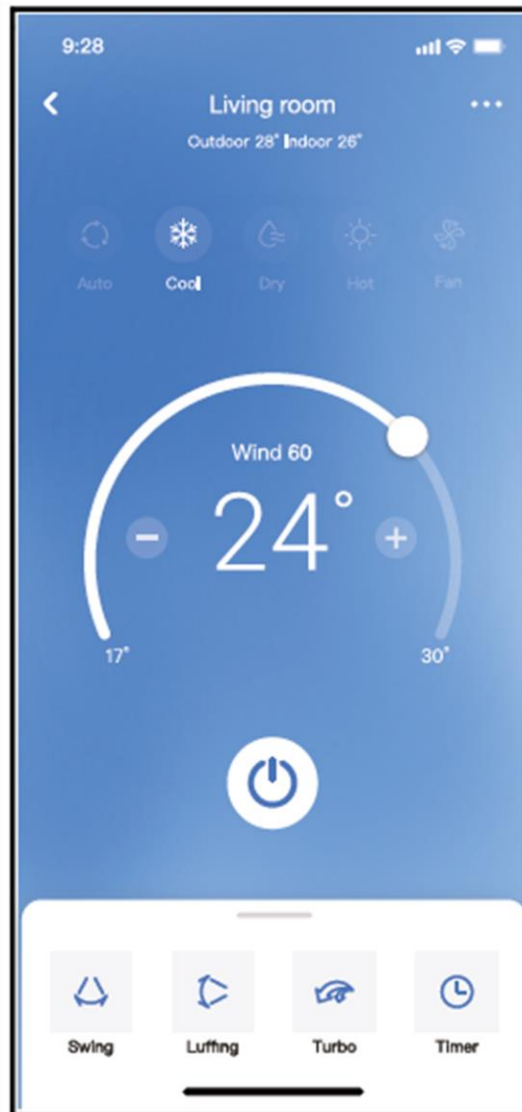

3. Thus, user can control air conditioners on/off status, operation mode, temperature, fan speed and so on.

Note:

Not all functions of the application are available for air conditioner control. For example: ECO, Turbo, Swing functions. Please check the user manual to find more information.

VII. SPECIAL FUNCTIONS

Schedules

On a weekly basis, the user can schedule the air conditioner to turn on or off at a certain time. The user can also check the weekly operation of the air conditioner.

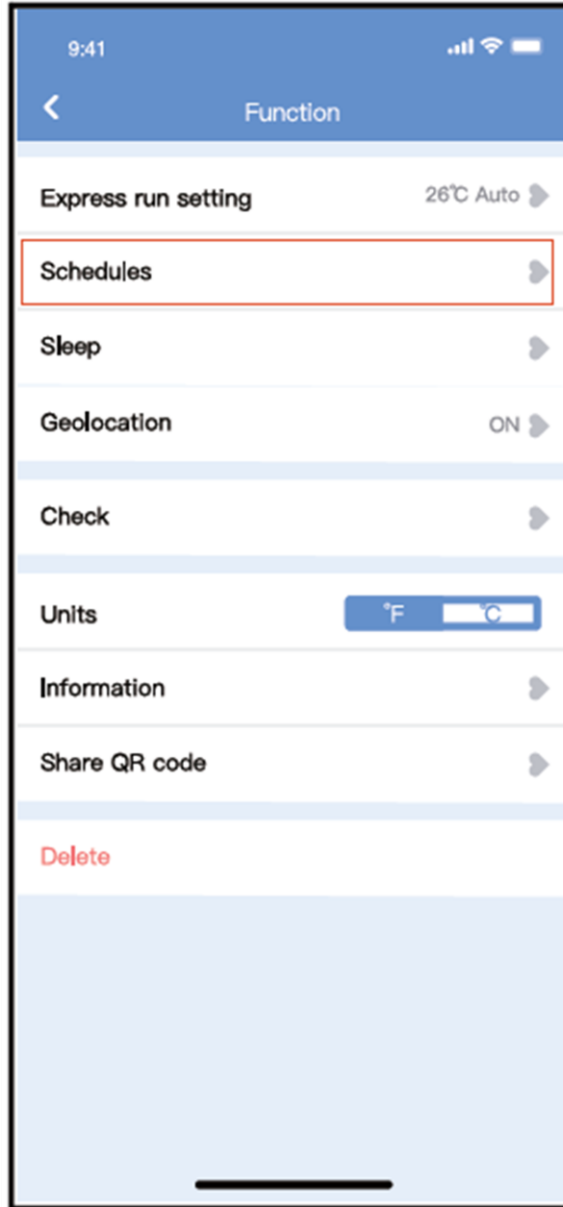

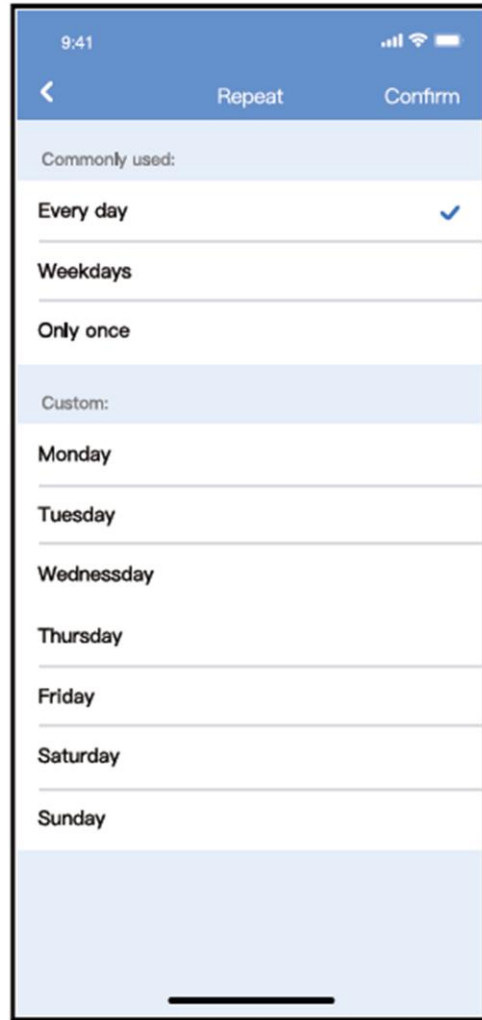
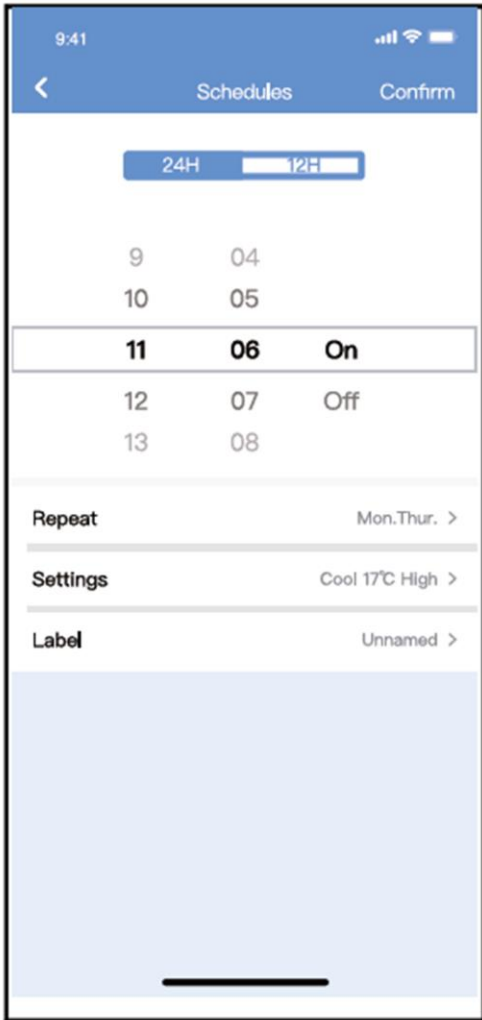

Sleep

Users can set the temperature for a comfortable sleep.

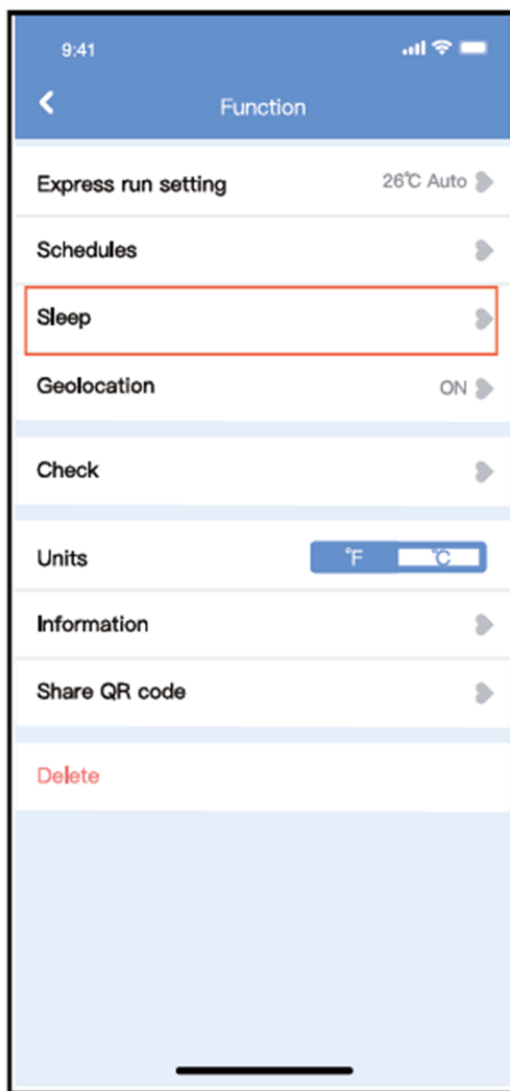

Check

With this function, the user can check the operating status of the air conditioner. Upon completion of the verification, operation issues and detailed information may be displayed.

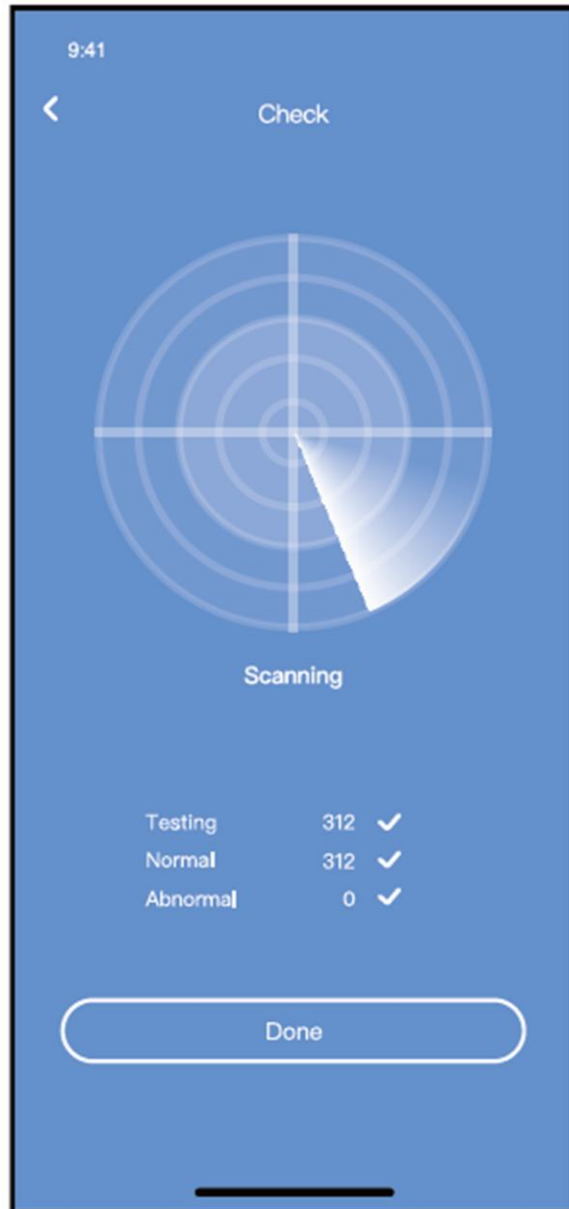

Share device

The air conditioner can be controlled by multi-users at the same time by Share Device function.



1. Click "Shared QR code"



2. The QR code is displayed

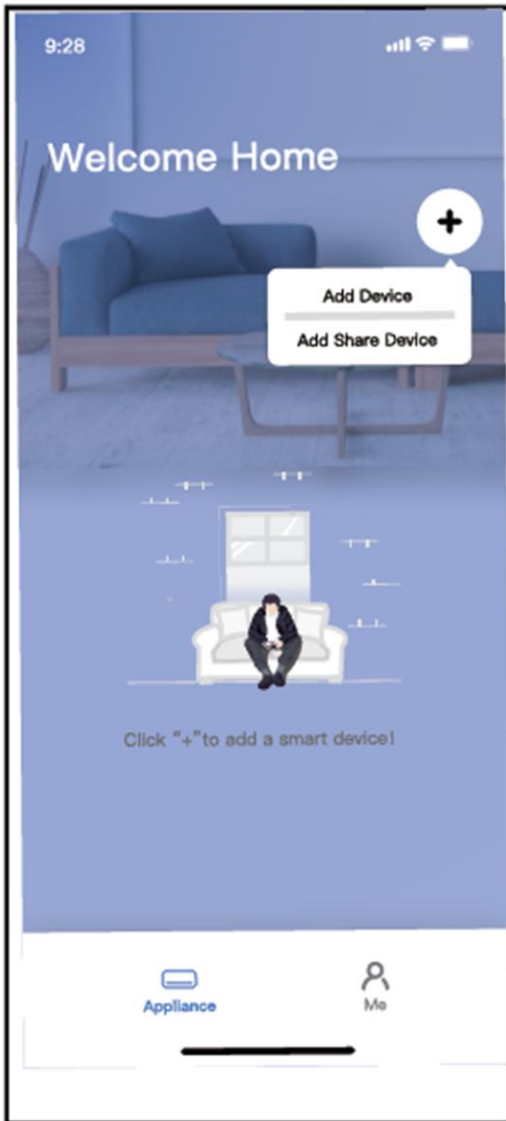

3. Other users must first sign in to the "Nethome Plus" app, touch the "Add Share Device" button on their mobile device, and then scan the QR code.

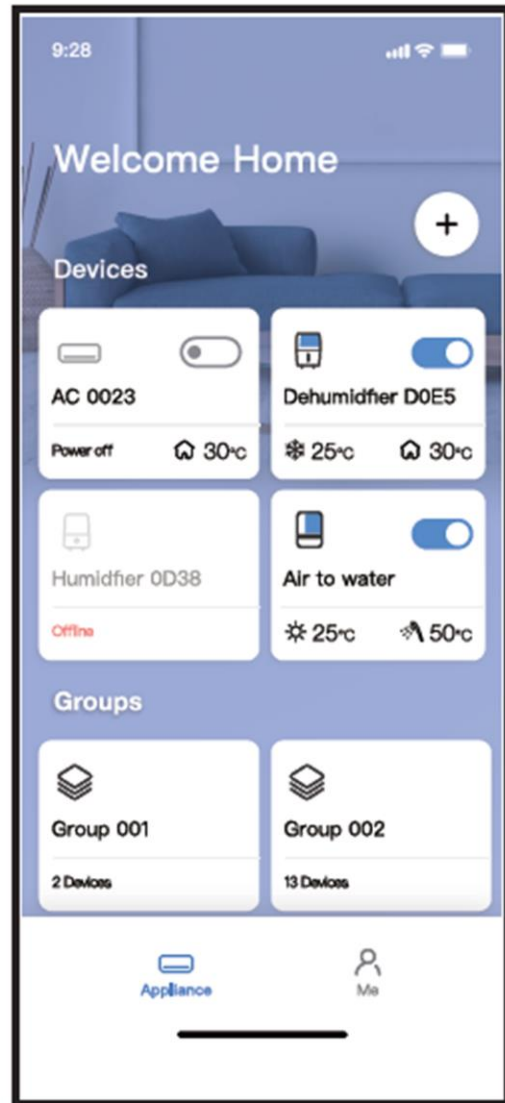

4. Users can then add the shared device.

Precautions:

For models US-OSK105, EU-OSK105:

FCC ID:2AS2HMZNA21 IC:24951-MZNA21

This device complies with Part 15 of the FCC rules and it contains licence-exempt transmitter(s)/receiver(s) that comply with Innovation, Science and Economic Development Canada's licence-exempt RSS(s).

Operation is subject to the following two conditions:

1. This device may not cause interference.
2. This device must accept any interference, including interference that may cause undesired operation of the device.

Only operate the device in accordance with the instructions supplied.

Changes or modifications to this unit not expressly approved by the party responsible for compliance could void the user's authority to operate the equipment.

This device complies with FCC radiation exposure limits set forth for an uncontrolled environment. To avoid the possibility of exceeding the FCC radio frequency exposure limits, human proximity to the antenna shall not be less than 20 cm (8 inches) during normal operation.

Note:

This equipment has been tested and found to comply with the limits for a Class B digital device, pursuant to part 15 of the FCC Rules. These limits are designed to provide reasonable protection against harmful interference in a residential installation. This equipment generates, uses and can radiate radio frequency energy and, if not installed and used in accordance with the instructions, may cause harmful interference to radio communications. However, there is no guarantee that interference will not occur in a particular installation. If this equipment does cause harmful interference to radio or television reception, which can be determined by turning the equipment off and on, the user is encouraged to try to correct the interference by one or more of the following measures:

- Reorient or relocate the receiving antenna.
- Increase the separation between the equipment and receiver.
- Connect the equipment into an outlet on a circuit different from that to which the receiver is connected.
- Consult the dealer or an experienced radio/TV technician for help.

The company is not responsible for problems and malfunctions caused by the Internet, wireless routers, or smart devices. For further assistance, please contact the appropriate provider.



Environment friendly disposal

You can help protect the environment!

Please remember to respect the local regulations: hand in the non-working electrical equipment's to an appropriate waste disposal center.



HEINNER is a registered trademark of **Network One Distribution SRL**. Other brands and product names are trademarks or registered trademarks of their respective holders.

No part of the specifications may be reproduced in any form or by any means or used to make any derivative such as translation, transformation, or adaptation without permission from NETWORK ONE DISTRIBUTION.

Copyright © 2013 Network One Distribution. All rights reserved.

www.heinner.com, <http://www.nod.ro>



This product is in conformity with norms and standards of European Community.

Importer: **Network One Distribution**

Marcel Iancu Street, 3-5, Bucharest, Romania

Tel: +40 21 211 18 56, www.heinner.com , www.nod.ro

HEINNER

GHID DE UTILIZARE ȘI INSTALARE PENTRU CONTROL WIRELESS

Modele:

HAC-CR09KITWIFI	HAC-CR18WIFI	HAC-CO12WFN-WH	HAC-MRB12SLWIFI
HAC-CR12WIFI	HAC-CR18KITWIFI	HAC-CO12WFN-RD	HAC-MRB12WHWIFI
HAC-CR12KITWIFI	HAC-CR24WIFI	HAC-CO12WFN-SL	HAC-BP12WIFI-BK
	HAC-CR24KITWIFI	HAC-CO12WFN-GD	HAC-CLS12WHWIFI

DECLARAȚIE DE CONFORMITATE

Declarăm prin prezenta că acest kit Wi-Fi este în conformitate cu cerințele esențiale și alte dispoziții relevante ale Directivei 2014/53/UE.

CARACTERISTICI

Model: EU-OSK105, US-OSK105

Standard: IEEE 802. 11b/g/n

Tip antenă: antenă cu circuit imprimat

Bandă de frecvențe: 2400 - 2483,5 MHz

Temperatură de funcționare: 0°C~45°C/32°F~113°F

Umiditate admisă: 10%~85%

Putere de intrare: DC 5V/300mA

Putere TX maximă: <20dBm

MĂSURI DE PRECAUȚIE

Sisteme de operare: iOS, Android.

- Vă rugăm să mențineți aplicația actualizată la cea mai recentă versiune.
- Date fiind situațiile speciale care pot apărea, menționăm următoarele: Nu toate sistemele cu Android și iOS sunt compatibile cu aplicația. Nu ne asumăm răspunderea pentru problemele apărute ca urmare a incompatibilității.

Securitatea wireless a kitului

Kitul Wi-Fi suportă numai metodele de criptare WPA-PSK/WPA2-PSK și rețelele necriptate. Se recomandă criptarea WPA-PSK/WPA2-PSK.

Atenționări

- Date fiind diferitele situații care pot exista în timpul utilizării rețelei, procesul de control poate întâmpina probleme. În această situație, este posibil ca informațiile de pe dispozitiv și cele din aplicație să nu fie aceleași.
- Camera smartphone-ului trebuie să aibă o rezoluție de cel puțin 5 mp pentru scanarea corectă a codului QR.
- Date fiind diferitele situații care pot exista în timpul utilizării rețelei, este posibilă expirarea timpului de așteptare a solicitării (request timeout), fiind necesară reconfigurarea rețelei.
- Pentru îmbunătățirea funcțiilor produsului, aplicația poate face obiectul actualizării fără o notificare prealabilă. Procesul propriu-zis de configurare a rețelei poate fi ușor diferit de cel prezentat în manual.

II. DESCĂRCAREA ȘI INSTALAREA APLICAȚIEI

Atenție: Codul QR de mai jos este disponibil numai pentru descărcarea aplicației. Acesta este total diferit de codul QR aplicat pe kitul Wi-Fi.



Android



iOS

- Pentru utilizatorii de telefoane cu Android: scanați codul QR sau accesați Google Play, căutați aplicația „NetHome Plus” și descărcați-o.
- Pentru utilizatorii de telefoane cu iOS: scanați codul QR sau accesați App Store, căutați aplicația „NetHome Plus” și descărcați-o.

III. INSTALAREA KITULUI WIFI (MODULULUI WIRELESS)

1. Scoateți capacul de protecție al kitului Wi-Fi (modulului wireless)
2. Deschideți panoul frontal și introduceți kitul Wi-Fi în interfața specială
3. Lipiți pe partea laterală a aparatului de aer condiționat codul QR livrat împreună cu kitul Wi-Fi (modulul wireless), asigurându-vă că acesta poate fi scanat ușor cu smartphone-ul. Alternativ, utilizatorul poate face o fotografie a codului QR și o poate salva în telefon.

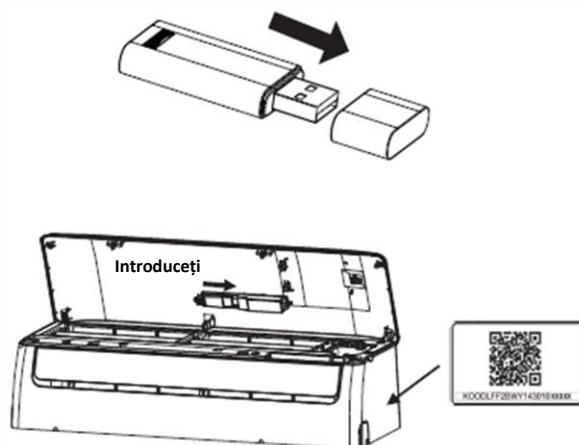

Avertisment: Această interfață este compatibilă numai cu kitul Wi-Fi (modulul wireless) furnizat de către producător.

IV. ÎNREGISTRAREA UTILIZATORULUI

- Vă rugăm să vă asigurați că dispozitivul dumneavoastră mobil este conectat la routerul Wi-Fi. De asemenea, înainte de înregistrarea utilizatorului și de configurarea rețelei, routerul Wi-Fi trebuie să fie conectat la Internet.
- Vă recomandăm să vă conectați la căsuța de e-mail și să activați înregistrarea prin accesarea linkului, în caz de uitare a parolei. Vă puteți autentifica utilizând contul.

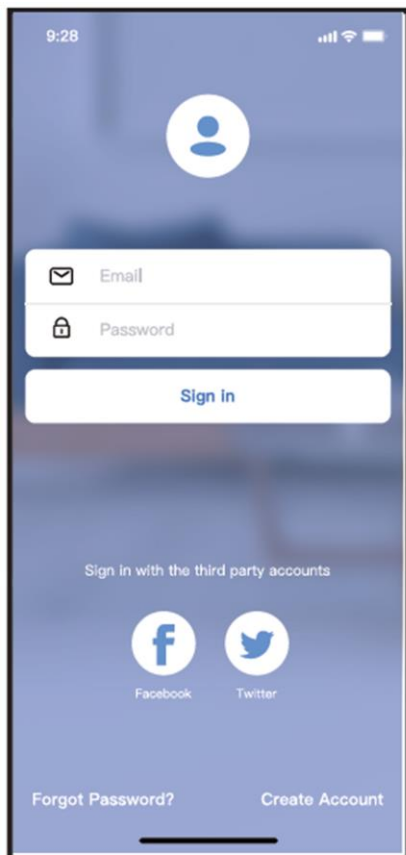

Android

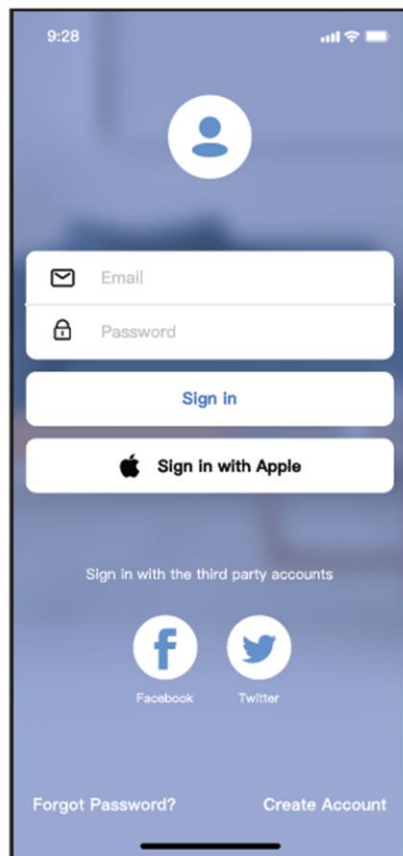

iOS

1. Atingeți butonul „Create Account”.

9:41

Create Account

Enter your Email address

Password

Confirm Password

Password need 6-20 characters,must contain letters and numbers.

Register

I have read and agree to the terms and privacy

2. Introduceți adresa de e-mail și parola, apoi atingeți butonul „Register”.

Măsuri de precauție:

- Este necesar să ștergeți configurațiile pentru celelalte rețele Wi-Fi din zonă și să vă asigurați că dispozitivului dumneavoastră cu iOS sau Android se conectează la rețeaua Wi-Fi pe care doriți să o configurați.
- Asigurați-vă că funcția Wi-Fi a dispozitivului dumneavoastră cu iOS sau Android este activă și că dispozitivul mobil se poate reconecta automat la rețeaua Wi-Fi.

Vă rugăm să rețineți:

Utilizatorul trebuie să parcurgă toți pașii în termen de 8 minute de la pornirea aparatului de aer condiționat. În caz contrar, aparatul trebuie pornit din nou.

Utilizarea dispozitivului Android sau iOS pentru configurarea rețelei

- Asigurați-vă că dispozitivul dumneavoastră mobil a fost deja conectat la rețeaua wireless pe care doriți să o utilizați. De asemenea, este necesar să ignorați alte rețele wireless în cazul în care acestea influențează procesul de configurare.
- Deconectați aparatul de aer condiționat de la sursa de alimentare.
- Conectați aparatul de aer condiționat la sursa de alimentare, apoi apăsați pe butonul „LED DISPLAY” sau pe butonul „DO NOT DISTURB” de 7 ori în 10 secunde.
- Atunci când ecranul aparatului afișează mesajul „AP”, înseamnă că modulul wireless al aparatului de aer condiționat a activat modul „AP”.

Observație:

Sunt disponibile două metode de finalizare a configurării rețelei:

- Configurarea rețelei prin scanare Bluetooth.
- Configurarea rețelei prin selectarea tipului de dispozitiv.

Configurarea rețelei prin scanare Bluetooth

Observație: Asigurați-vă că funcția Bluetooth a dispozitivului dumneavoastră mobil este activă.

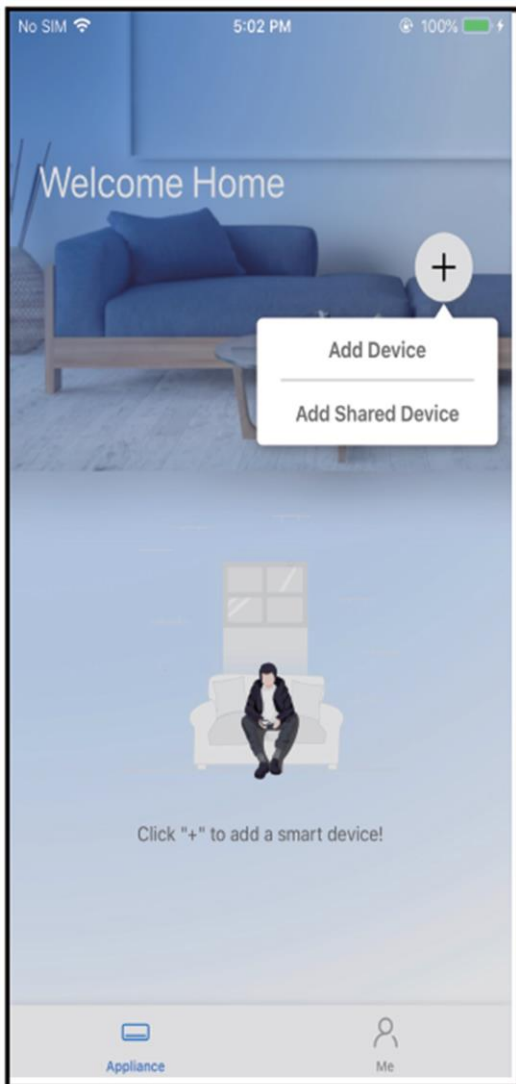

1. Atingeți butonul „+ Add device”

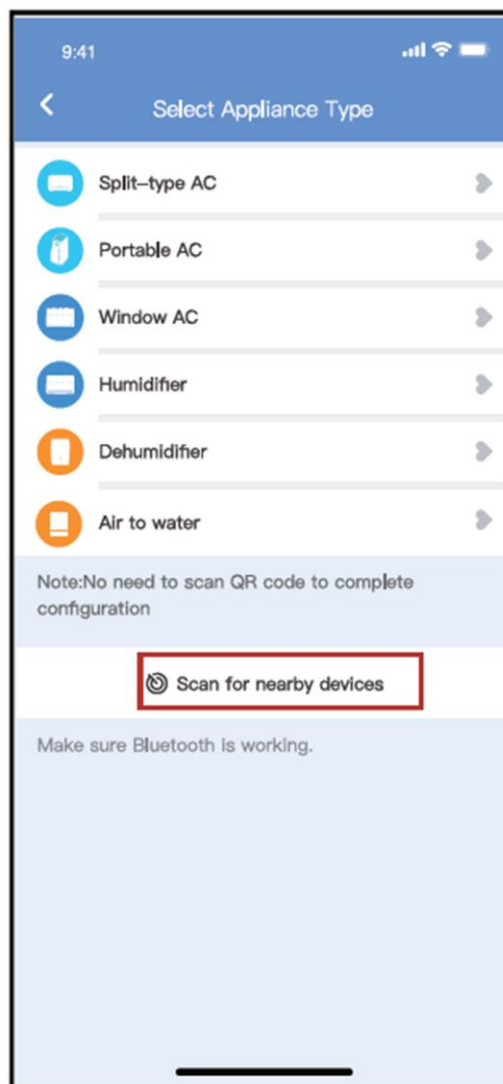

2. Atingeți butonul „Scan for nearby devices”

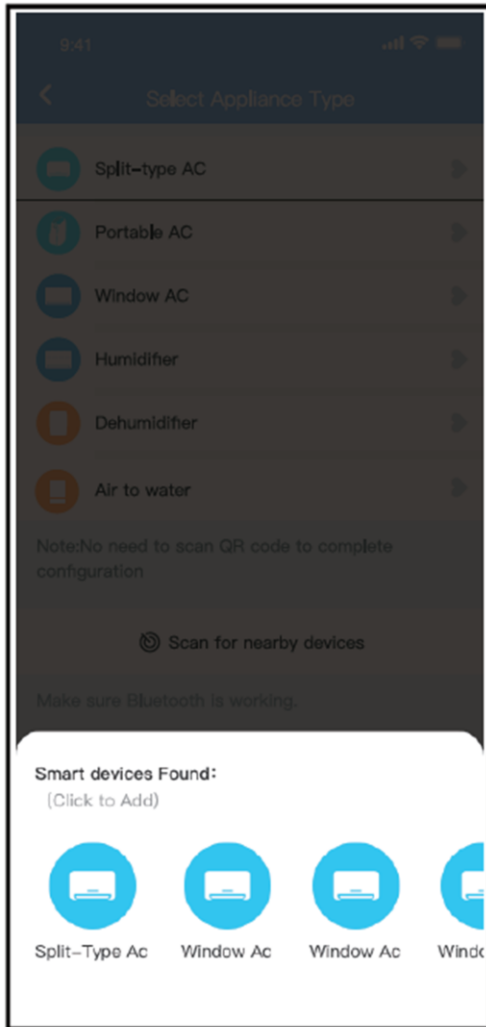

3. Așteptați până la găsirea dispozitivelor inteligente, apoi atingeți pictograma aferentă dispozitivului dorit.

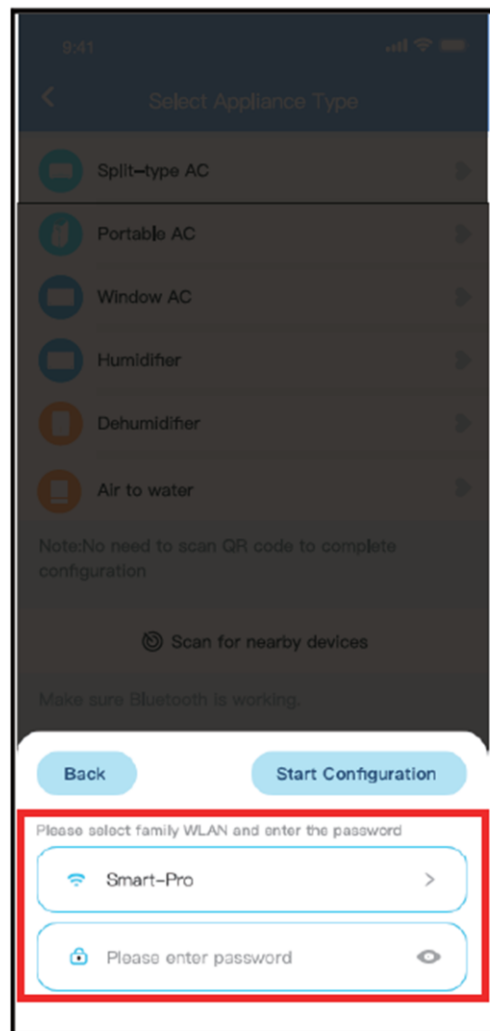

4. Selectați rețeaua Wi-Fi, apoi introduceți parola.

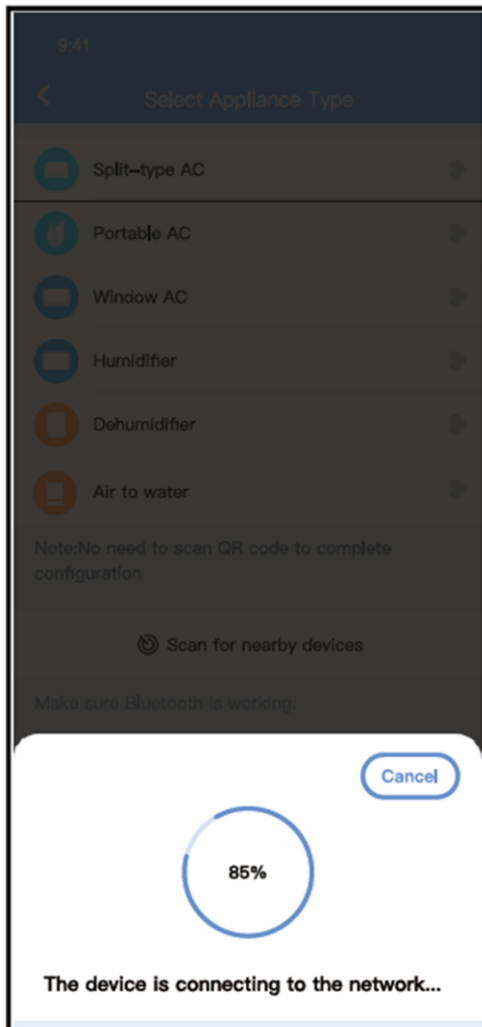

5. Așteptați până la conectarea la rețea.

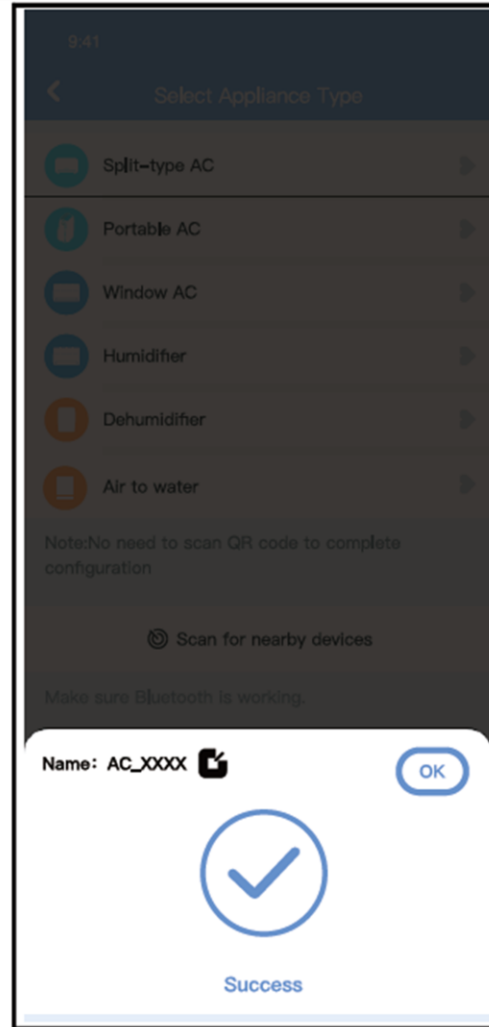

6. Configurarea a fost finalizată; puteți modifica denumirea implicită.



7. Puteți selecta o denumire existentă sau o denumire nouă.

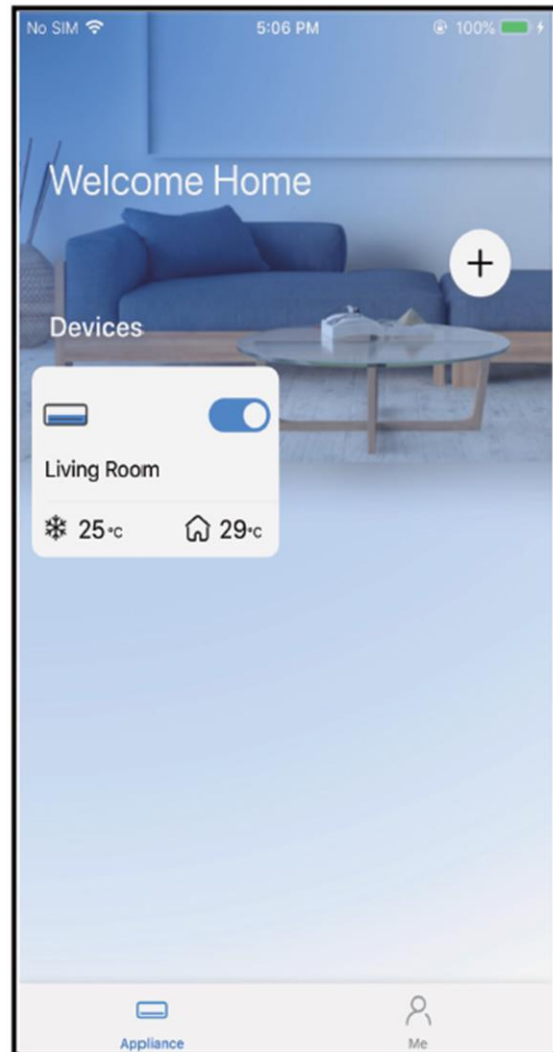

8. Configurarea rețelei prin Bluetooth a fost finalizată; puteți observa dispozitivul în listă.

Configurarea rețelei prin selectarea tipului de dispozitiv

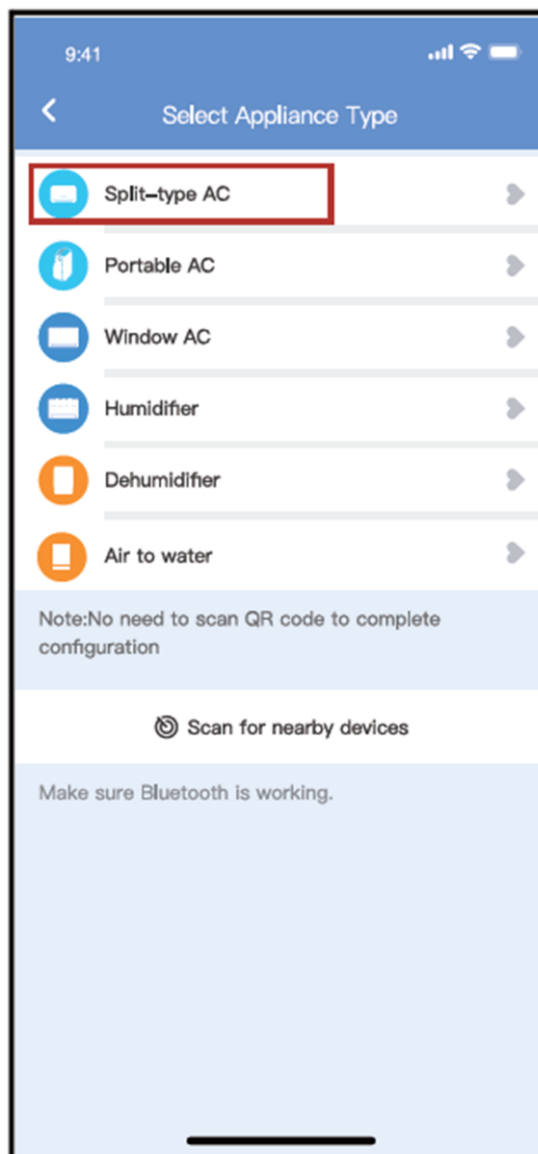

1. În cazul în care configurarea rețelei prin Bluetooth nu este realizată cu succes, vă rugăm să selectați tipul de dispozitiv.

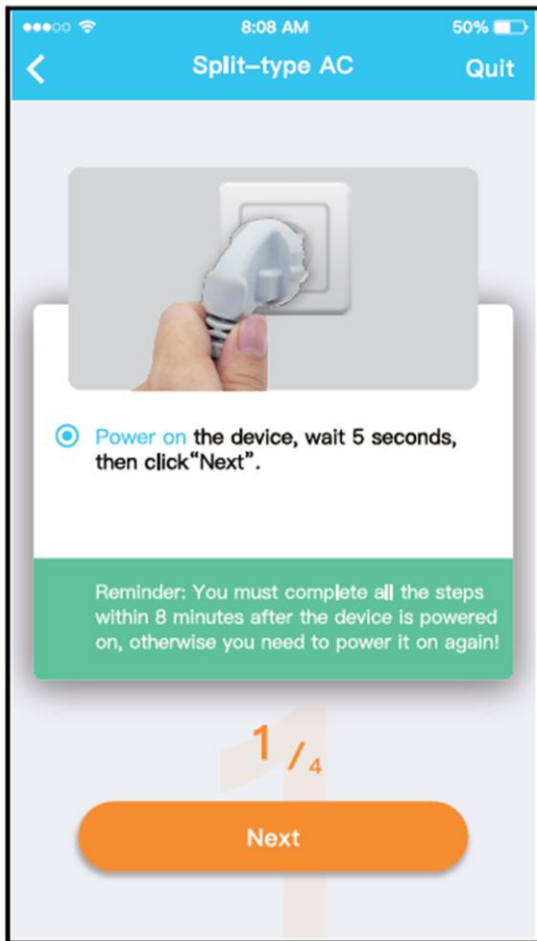

2. Vă rugăm să parcurgeți pașii de mai jos pentru a activa modul „AP”.

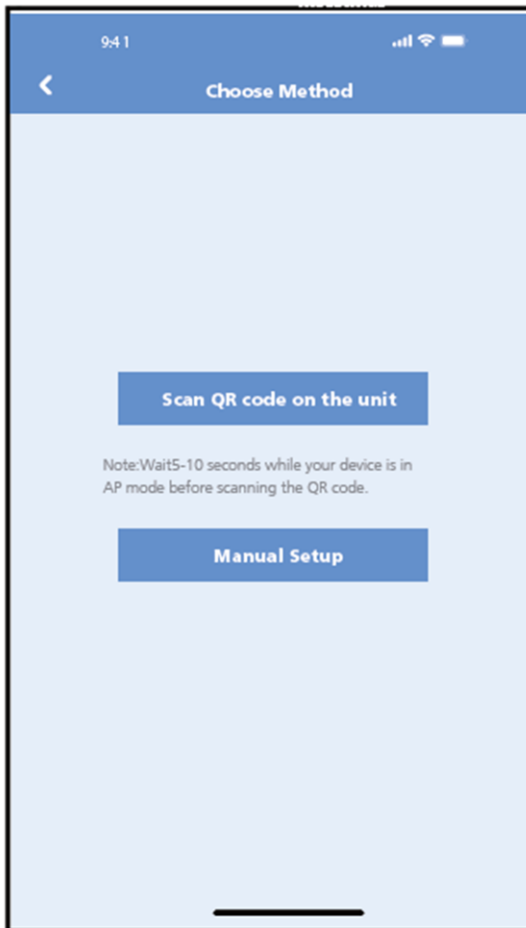

3. Selectați metoda de configurare a rețelei.

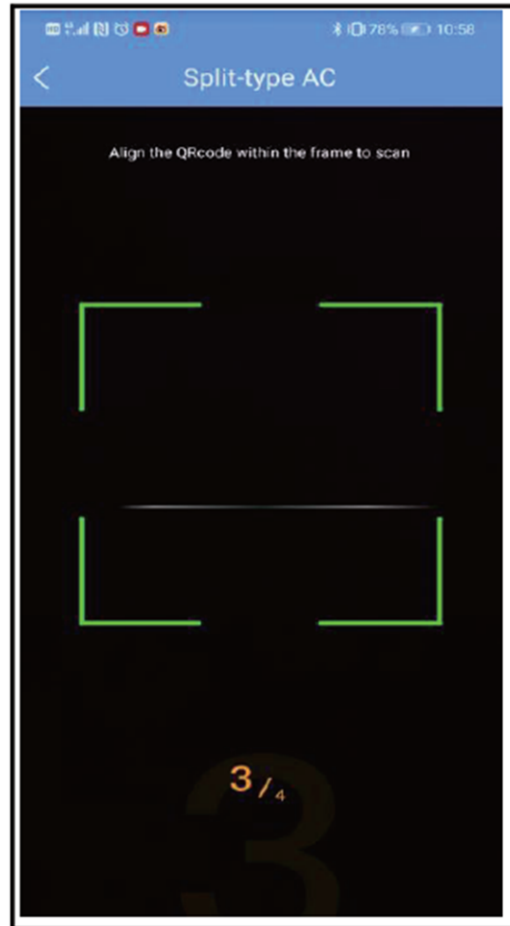

4. Selectați metoda „Scan QR code”.

Observație: Pașii 3 și 4 sunt aplicabili numai pentru sistemul Android. În cazul sistemului iOS, acești doi pași nu sunt necesari.



5. Selectați metoda „Manual setup” (Android). Conectați dispozitivul la rețeaua wireless (iOS).

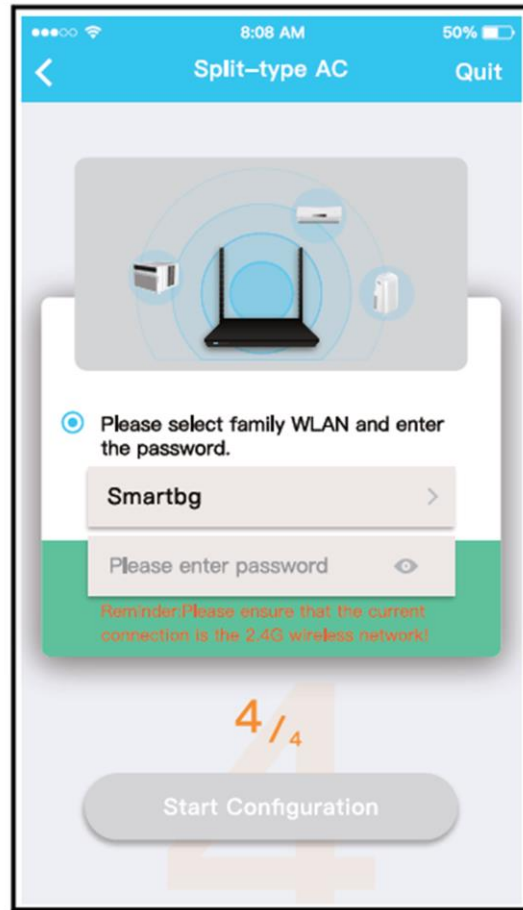

6. Vă rugăm să introduceți parola.

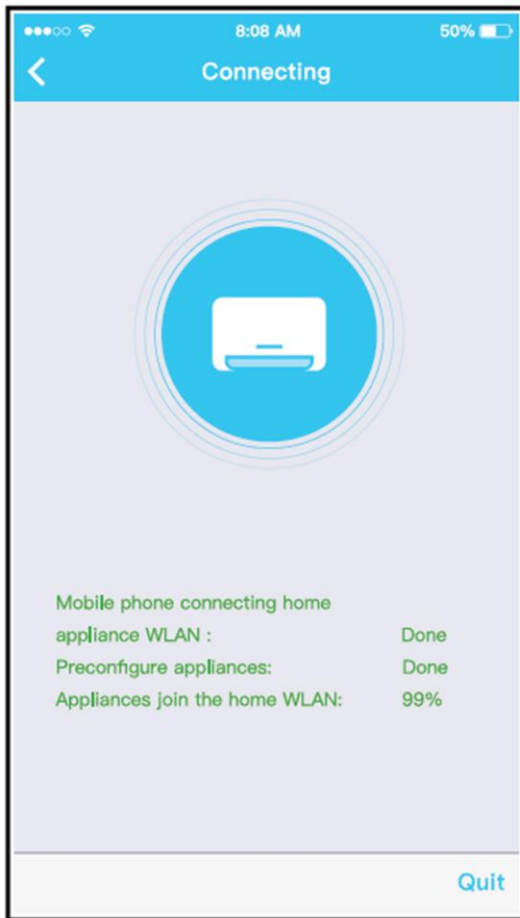

7. Configurarea rețelei a reușit.

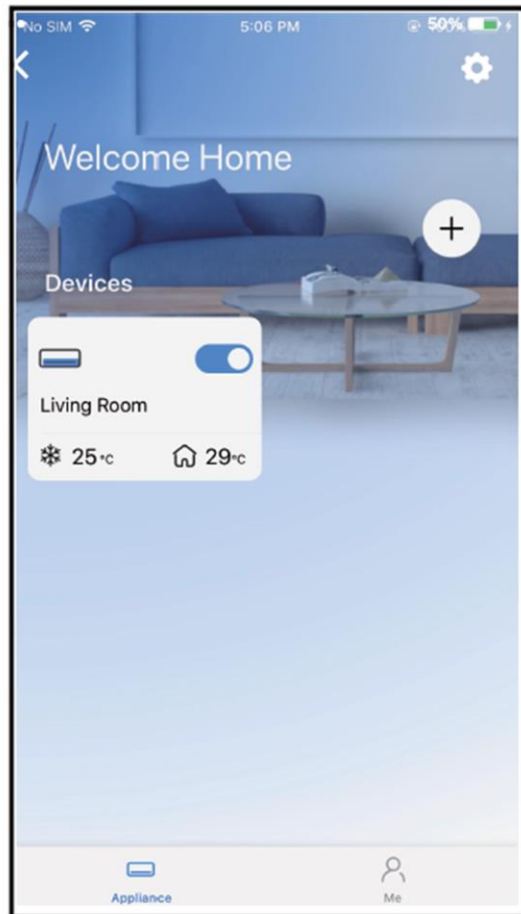

8. Configurarea a reușit, iar dispozitivul va fi afișat în listă.

Observație:

- După finalizarea configurării rețelei, aplicația va afișa pe ecran mesaje de confirmare a configurării.
- Date fiind situațiile speciale care pot exista în timpul utilizării conexiunii la Internet, este posibil ca starea afișată a dispozitivului să fie „offline”. În acest caz, este necesar să reîmprospătați lista de dispozitive din aplicație și să vă asigurați că starea dispozitivului este online. Alternativ, puteți deconecta aparatul de la sursa de alimentare și îl puteți reconecta, iar starea dispozitivului va deveni „online” după câteva minute.

VI. INSTRUCȚIUNI DE UTILIZARE A APLICAȚIEI

Înainte de a utiliza aplicația pentru controlarea aparatului de aer condiționat prin Internet, vă rugăm să vă asigurați că dispozitivul mobil și aparatul de aer condiționat sunt conectate la Internet.

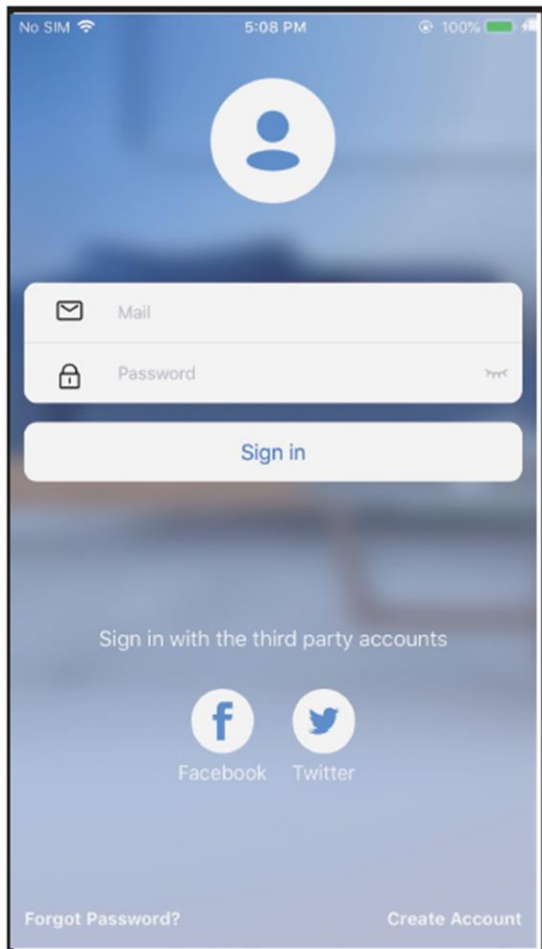

1. Atingeți butonul „Sign in”

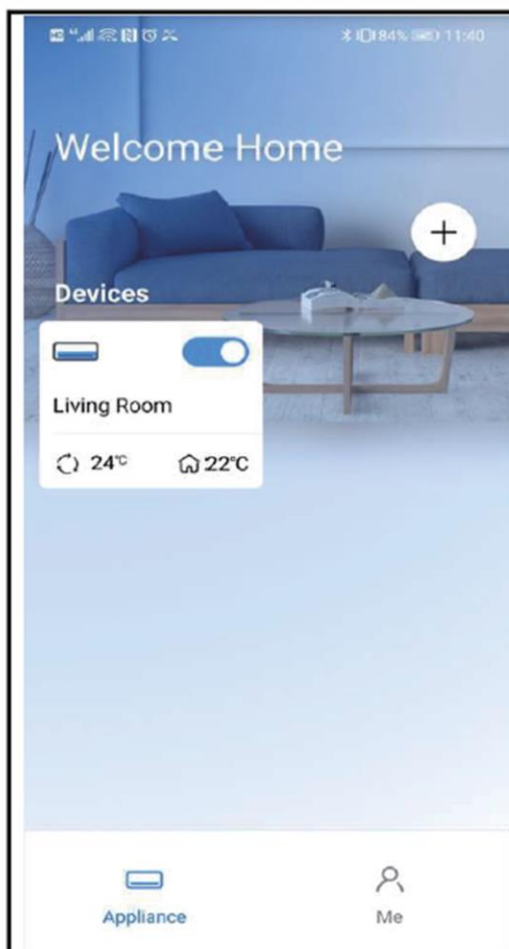

2. Selectați aparatul de aer condiționat

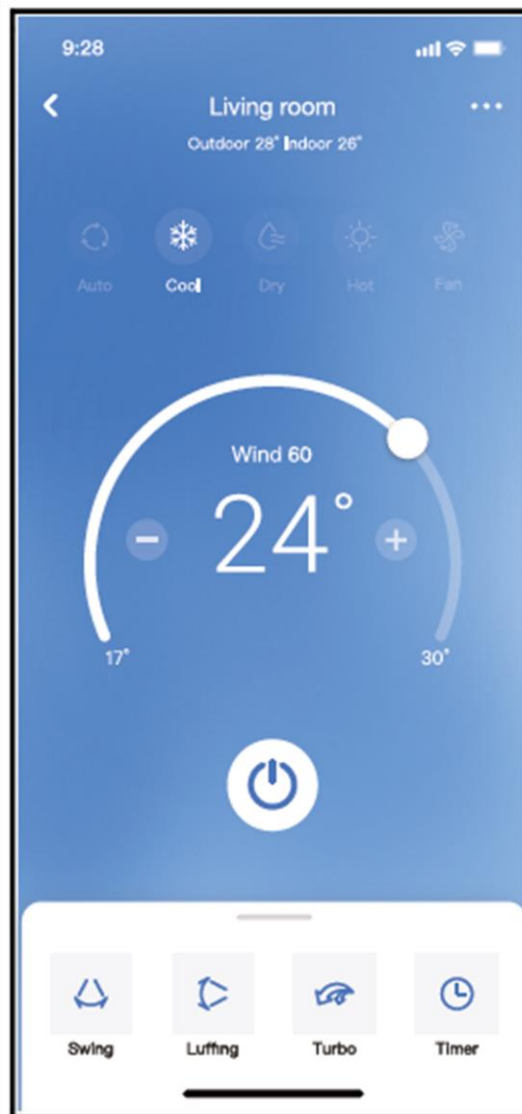

3. Astfel, utilizatorul poate controla pornirea/oprirea aparatelor de aer condiționat, modul de funcționare, temperatura, viteza ventilatorului și așa mai departe.

Observație:

Nu toate funcțiile aplicației sunt disponibile pentru controlul aparatului de aer condiționat. De exemplu: funcțiile ECO, Turbo, Swing. Pentru mai multe informații, consultați manualul de utilizare.

Funcția „Schedules”

Săptămânal, utilizatorul poate programa pornirea sau oprirea aparatului de aer condiționat la o anumită oră. De asemenea, utilizatorul poate controla funcționarea săptămânală a aparatului de aer condiționat.

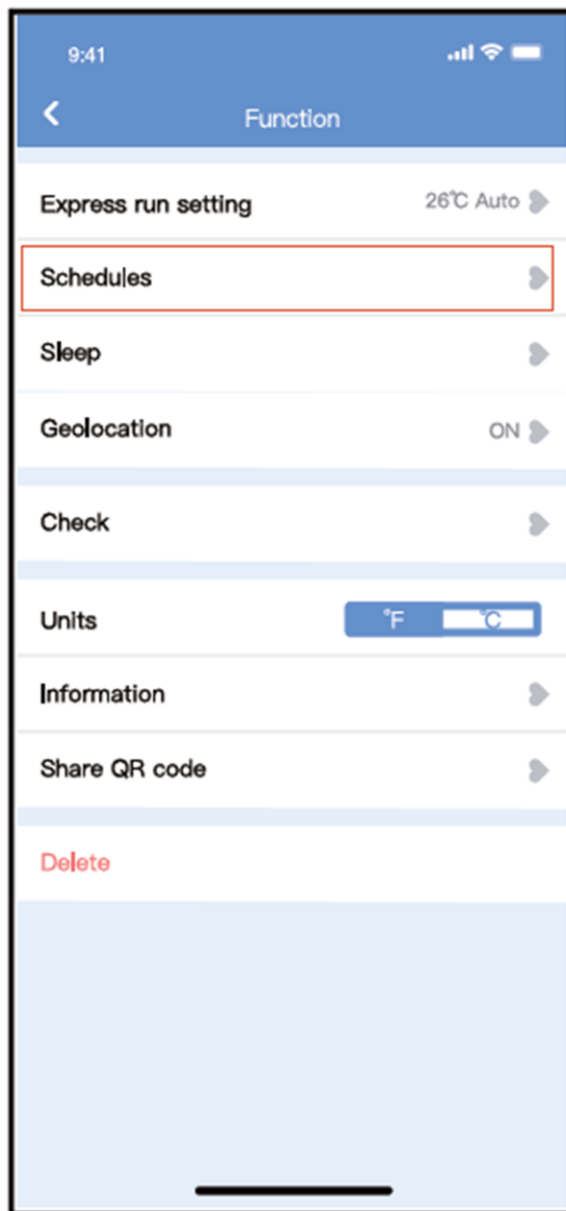

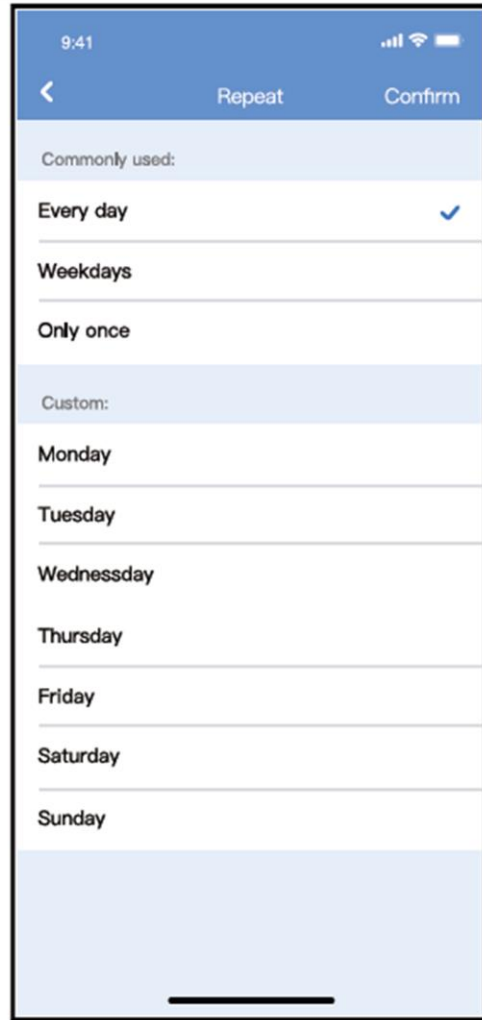
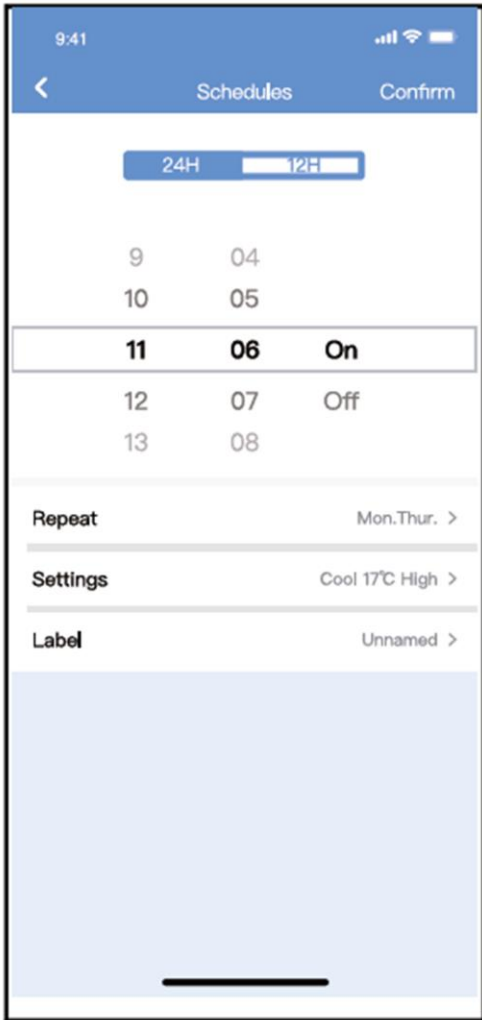

Funcția Sleep (Somn)

Utilizatorii pot configura temperatura pentru un somn confortabil.

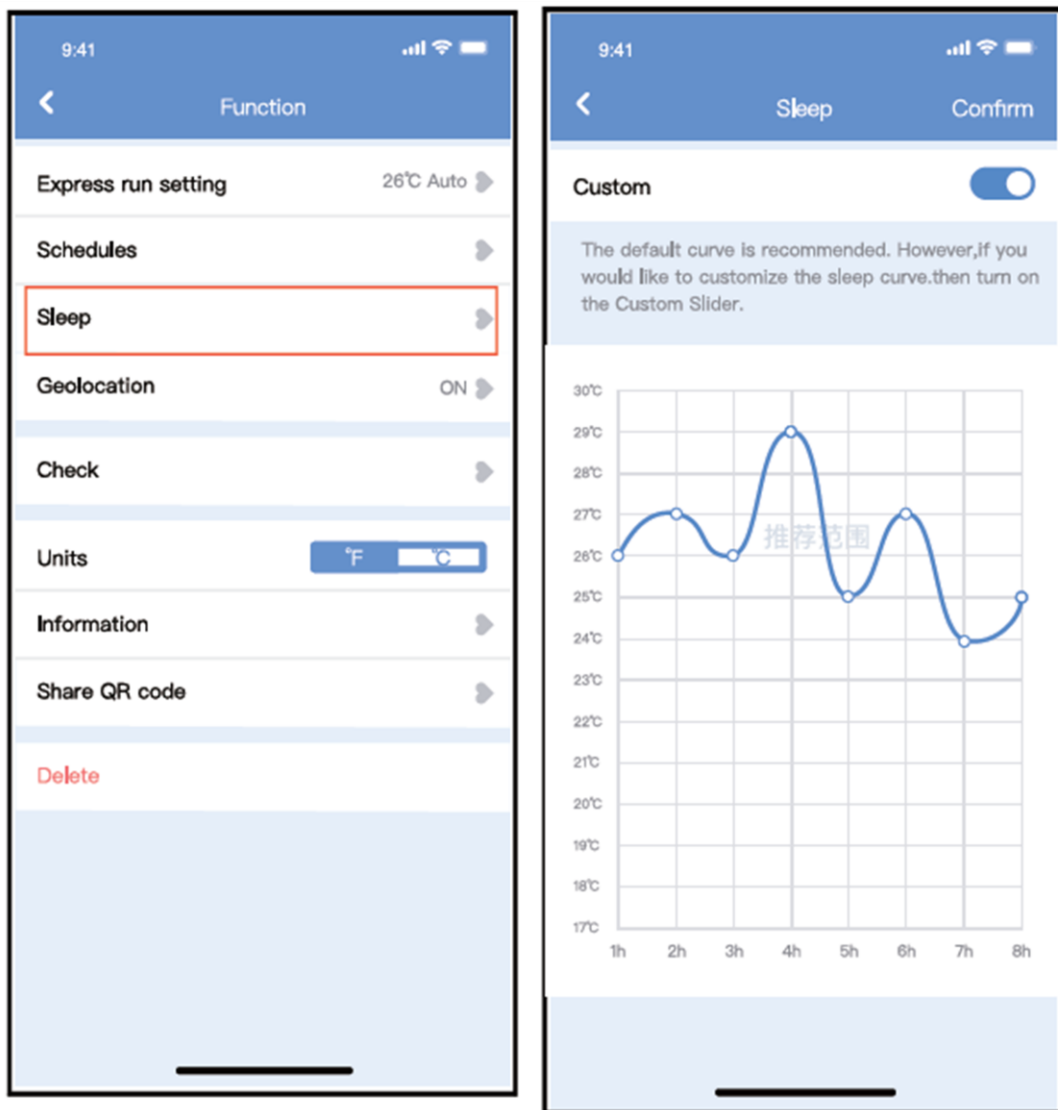

Funcția Check (Verificare)

Cu ajutorul acestei funcții, utilizatorul poate verifica starea de funcționare a aparatului de aer condiționat. La finalizarea operației de verificare, pot fi afișate problemele de funcționare și informații detaliate.

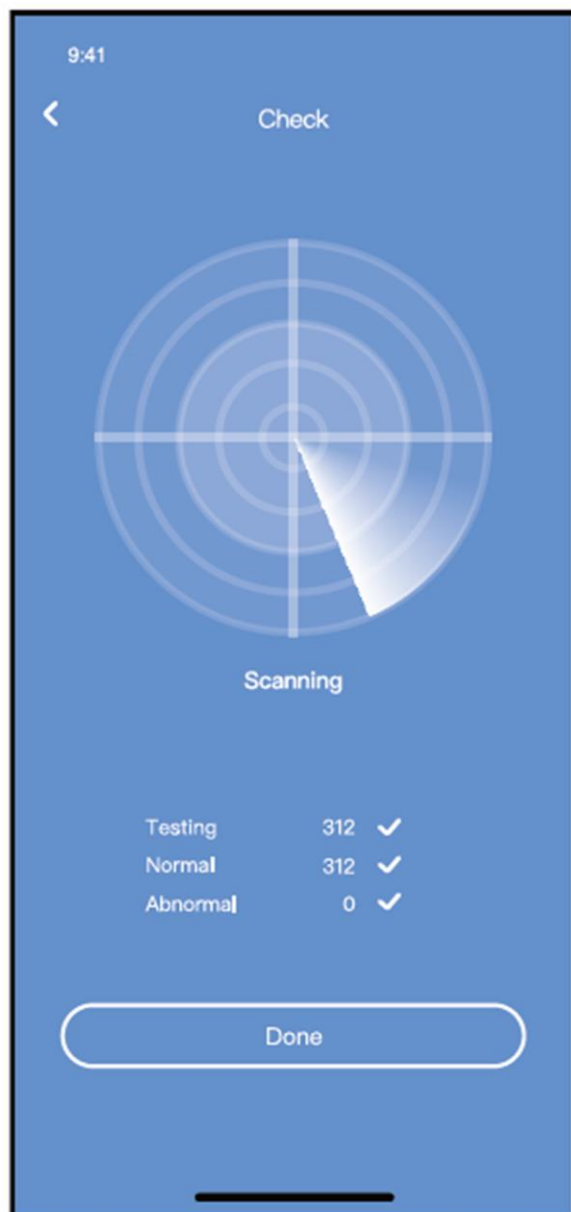

Partajarea dispozitivului

Aparatul de aer condiționat poate fi controlat simultan de mai mulți utilizatori prin intermediul funcției „Share Device” (Partajare dispozitiv).



1. Atingeți butonul „Shared QR code”



2. Se afișează codul QR

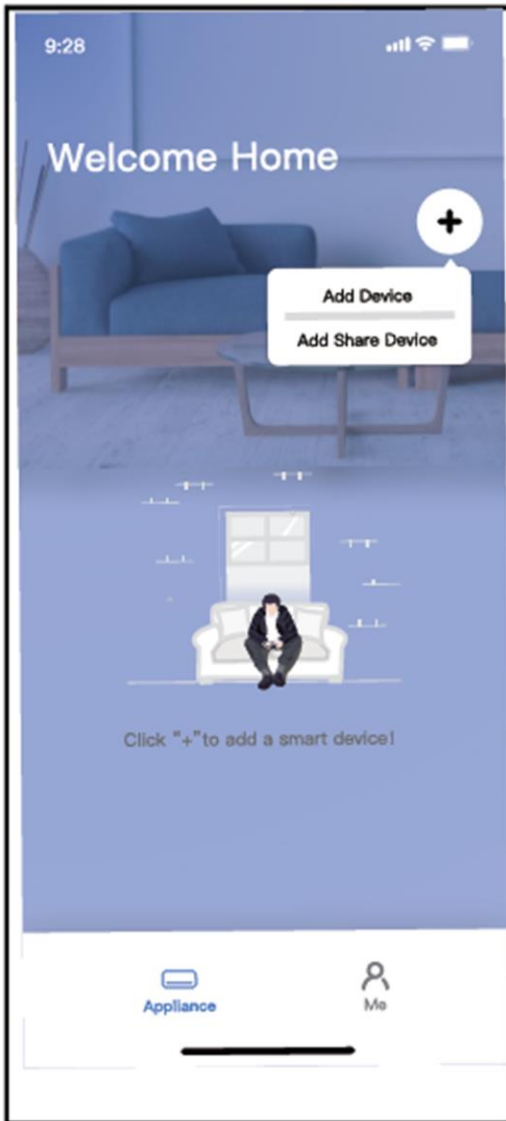

3. Ceilalți utilizatori trebuie mai întâi să se conecteze în aplicația „Nethome Plus”, să atingă butonul „Add Share Device” pe dispozitivul mobil, apoi să scaneze codul QR.



4. Apoi utilizatorii pot adăuga dispozitivul partajat.

Măsuri de precauție:

Pentru modelele US-OSK105, EU-OSK105:

FCC ID:2AS2HMZNA21 IC:24951-MZNA21

Acest dispozitiv este în conformitate cu partea 15 din Regulile FCC și conține transmițător(oare)/ receptor(are) scutite de licență care respecta RSS Innovation, Science and Economic Development (specificațiile standardelor radio Inovație, Știință și Dezvoltare Economică) scutite de licență din Canada.

Utilizarea face obiectul următoarelor două condiții:

1. Acest dispozitiv nu trebuie să cauzeze interferențe.
2. Acest dispozitiv trebuie să accepte orice interferență, inclusiv interferențe care pot cauza o funcționare nedorită a aparatului.

Utilizați dispozitivul numai în conformitate cu instrucțiunile furnizate.

Orice schimbări sau modificări care nu sunt aprobate în mod expres de către partea care asigură conformitatea pot anula dreptul utilizatorului de a folosi acest produs.

Acest echipament respectă limitele de expunere la radiații stabilite de FCC pentru un mediu necontrolat. Pentru a evita posibilitatea depășirii limitelor de expunere la radiații stabilite de FCC, distanța dintre persoane și antenă nu trebuie să fie mai mică de 20 de cm în timpul funcționării normale.

Observație:

Acest echipament a fost testat și s-a dovedit că respectă limitele pentru dispozitive digitale de Clasă B, în conformitate cu Partea 15 a Regulilor FCC. Aceste limite sunt concepute astfel încât să asigure o protecție adecvată împotriva interferențelor dăunătoare în cazul unei instalări la domiciliu. Acest echipament generează, utilizează și poate emite energie de radiofrecvență și, în cazul în care nu este instalat și utilizat în conformitate cu instrucțiunile, poate provoca interferențe dăunătoare comunicațiilor radio. Cu toate acestea, nu există nicio garanție că nu se vor produce interferențe în cadrul unei anumite instalări. Dacă acest echipament produce interferențe dăunătoare recepției radio sau de televiziune, aspect care poate fi determinat prin oprirea și pornirea echipamentului, utilizatorul este sfătuit să încerce corectarea fenomenului de interferență prin una sau mai multe dintre următoarele măsuri:

- Reorientarea și re poziționarea antenei de recepție.
- Mărirea distanței dintre produs și receptor.
- Conectarea produsului la o priză care face parte din alt circuit decât cel la care este conectat receptorul.
- Consultarea distribuitorului sau a unui tehnician radio/TV calificat, în vederea obținerii de asistență.

Compania nu își asumă răspunderea pentru problemele și defecțiunile cauzate de Internet, routere wireless sau dispozitive inteligente. Pentru a obține ajutor suplimentar, vă rugăm să contactați furnizorul corespunzător.



MASURI PENTRU PROTECTIA MEDIULUI

Va informam ca persoanele fizice au urmatoarele obligatii prin legislatia specifica privind protectia mediului si regimul deseurilor:

- Deseurile de echipamente electrice si electronice (DEEE), pot contine substante periculoase pentru mediu si sanatatea umana. Conform OUG 5/2015, exista obligativitatea predarii acestora, pentru tratarea corespunzatoare si valorificarea componentelor reciclabile. Societatea Network One Distribution S.R.L. este platitoare de taxa de "timbru verde" pentru fiecare Echipament Electric si Electronic (EEE) pe care il pune pe piata. Acest cost asigura tratarea ulterioara a echipamentelor uzate colectate. Din acest motiv, odata ce devine deseou, produsul EEE poate fi predat gratuit operatorului Dvs. de salubritate, la magazine atunci cand achizitionati alt echipament similar, sistemul "unul la unu" sau la punctul de colectare organizat de Primaria Sectorului / localitatii Dvs.
- Simbolul (marcajul) aplicat produselor, care indica faptul ca deseurile DEEE, bateriile si acumulatorii - fac obiectul unei colectari separate, il reprezinta o pubela barata cu o cruce.



Aceste masuri vor ajuta la protejarea mediului

Societatea Network One Distribution S.R.L. este inregistrata in Registrul de punere pe piata a echipamentelor electrice si electronice, avand numarul de inregistrare: RO-2016-03-EEE-0201-IV. De asemenea, au fost intocmite si sunt gestionate: Registrul de Retragere EEE si Registrul de Rechemare EEE, in conformitate cu HG 322/2013. Totodata societatea este inregistrata in Registrul de punere pe piata a bateriilor, avand numarul de inregistrare: RO-2011-03-B&A-0283.

Conformitatea cu directiva RoHS: Produsul pe care l-ati cumparat este conform cu Directiva RoHS UE (2011/65/UE). Nu contine materialele daunatoare si interzise specificate in Directiva.

Va multumim ca participati alaturi de noi la protejarea mediului si a sanatatii umane!



HEINNER este o marcă înregistrată a **Network One Distribution SRL**. Alte mărci și nume de produs sunt mărci comerciale sau mărci comerciale înregistrate ale deținătorilor acestora.

Nici o parte din specificații nu poate fi reprodusă în orice formă sau prin niciun mijloc ori folosită pentru a produce orice fel de derivate, cum ar fi traducerea, transformare sau adaptarea fără permisiune de la NETWORK ONE DISTRIBUTION.

Copyright © 2013 Network One Distribution. Toate drepturile rezervate.

www.heinner.com, <http://www.nod.ro>

<http://www.heinner.com>, <http://www.nod.ro>



Acest produs este în conformitate cu normele și standardele Comunității Europene.

Importator: **Network One Distribution**

Marcel Iancu, 3-5, București, România

Tel: +40 21 211 18 56, www.heinner.com, www.nod.ro

HEINNER

РЪКОВОДСТВО ЗА УПОТРЕБА И ИНСТАЛИРАНЕ НА ПРИЛОЖЕНИЕТО WIRELESS

Модели:

HAC-CR09KITWIFI	HAC-CR18WIFI	HAC-CO12WFN-WH	HAC-MRB12SLWIFI
HAC-CR12WIFI	HAC-CR18KITWIFI	HAC-CO12WFN-RD	HAC-MRB12WHWIFI
HAC-CR12KITWIFI	HAC-CR24WIFI	HAC-CO12WFN-SL	HAC-BP12WIFI-BK
	HAC-CR24KITWIFI	HAC-CO12WFN-GD	HAC-CLS12WHWIFI

ДЕКЛАРАЦИЯ ЗА СЪОТВЕТСТВИЕ

С настоящото декларираме, че този Wi-Fi комплект е в съответствие с основните изисквания и други приложими разпоредби на Директива 2014/53/ЕС.

ХАРАКТЕРИСТИКИ

Модел: EU-OSK105, US-OSK105

Стандарт: IEEE 802.11b/g/n

Вид на антената: антена с печатна схема

Честотна лента: 2400 - 2483,5 MHz

Работна температура: 0°C~45°C/32°F~113°F

Допустима влажност: 10%~85%

Входна мощност: DC 5V/300 mA

Максимална мощност TX: <20dBm

ПРЕДПАЗНИ МЕРКИ

Операционни системи: iOS, Android.

- Моля, поддържайте приложението актуализирано с най-новата версия.
- Предвид специалните ситуации, които могат да възникнат, уточняваме следното: Не всички системи с Android и iOS са съвместими с приложението. Не поемаме отговорност за проблеми, възникнали поради несъвместимост.

Безжична сигурност на комплекта

Wi-Fi комплектът поддържа само методи за криптиране WPA-PSK/WPA2-PSK и некриптирани мрежи.

Препоръчва се криптиране WPA-PSK/WPA2-PSK.

Обръщане на внимание

- Поради различните ситуации, които могат да възникнат по време на използване на мрежата, може да има проблеми при процедурата за контрол. В тази ситуация е възможно информацията от устройството и тази от приложението да не е еднаква.
- Камерата на смартфона трябва да има резолюция най-малко 5 MP за правилно сканиране на QR кода.
- Поради различните ситуации, които могат да възникнат по време на използване на мрежата, възможно е времето за изчакване на искането да изтече (request timeout), като е необходимо повторно конфигуриране на мрежата.
- За подобряване на функциите на продукта, приложението може да бъде предмет на актуализиране без предварително уведомление. Самият процес на конфигуриране на мрежата може да бъде малко по-различен от този, представен в ръководството.

II. ИЗТЕГЛЯНЕ И ИНСТАЛИРАНЕ НА ПРИЛОЖЕНИЕТО

Внимание: QR кодът по-долу е достъпен само за изтегляне на приложението. Това е напълно различно от QR кода, приложен на Wi-Fi комплекта.



Android



iOS

- За потребители на телефони с Android: сканирайте QR кода или отидете в Google Play, потърсете приложението „NetHome Plus“ и го изтеглете.
- За потребители на телефони с iOS: сканирайте QR кода или отидете в App Store, потърсете приложението “NetHome Plus” и го изтеглете.

III. ИНСТАЛИРАНЕ НА КОМПЛЕКТА WIFI (БЕЗЖИЧНИЯ МОДУЛ)

1. Извадете защитния капак на Wi-Fi комплекта (безжичния модул).
2. Отворете предния панел и поставете Wi-Fi комплекта в специалния интерфейс.
3. Залепете върху страничната част на климатика QR кода, предоставен заедно с WIFI комплекта (безжичния модул), като се уверите, че кодът може да бъде лесно сканиран със смартфона. Алтернативно, потребителят може да направи снимка на QR кода и да я запази в телефона.

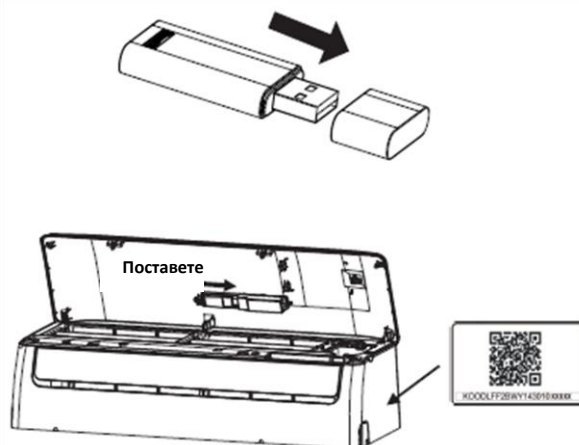

Предупреждение: Този интерфейс е съвместим само с комплекта Wi-Fi (безжичния модул), предоставен от производителя

IV. РЕГИСТРИРАНЕ НА ПОТРЕБИТЕЛЯ

- Моля, уверете се, че вашето мобилно устройство е свързано към Wi-Fi рутера. Също така, преди регистрацията на потребителя и конфигуриране на мрежата, Wi-Fi рутерът трябва да бъде свързан към Интернет.
- Препоръчваме ви да се свържете с пощенската си кутия и да активирате регистрацията чрез достъп до линка, ако забравите паролата си. Можете да влезете използвайки вашия акаунт.

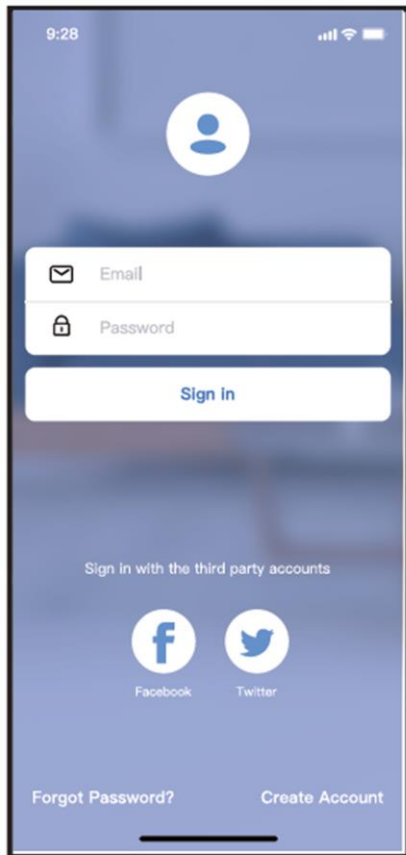

Android

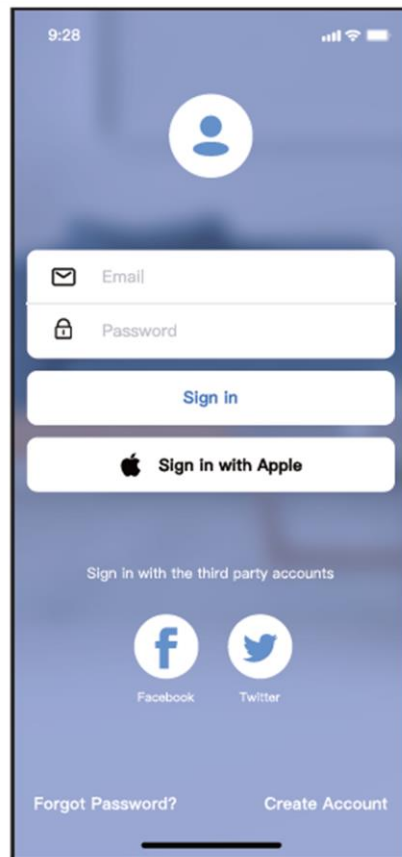

iOS

1. Докоснете бутона „Create Account“.

9:41

Create Account

Enter your Email address

Password

Confirm Password

Password need 6-20 characters,must contain letters and numbers.

Register

I have read and agree to the terms and privacy

2. Въведете имейл адреса и паролата, след това докоснете бутона „Register“.

Предпазни мерки:

- Необходимо е да изтриете конфигурациите за другите Wi-Fi мрежи в зоната и да се уверите, че вашето устройство с iOS или Android се свързва към Wi-Fi мрежата, която искате да конфигурирате.
- Уверете се, че Wi-Fi функцията на вашето устройство с iOS или Android е активна и че мобилното устройство може автоматично да се свърже отново с Wi-Fi мрежата.

Моля, запомнете:

Потребителят трябва да премине всички стъпки в рамките на 8 минути след включването на климатика. В противен случай, уредът трябва да се включи отново.

Използване на устройството с Android или iOS с цел конфигуриране на мрежата

- Уверете се, че вашето мобилно устройство вече е свързано към безжичната мрежа, която искате да използвате. Също така е необходимо да игнорирате други безжични мрежи, ако те засягат процеса на конфигуриране.
- Изключете климатика от източника на захранване.
- Свържете климатика към източника на захранване, след това натиснете бутона „LED DISPLAY“ или бутона „DO NOT DISTURB“ 7 пъти за 10 секунди.
- Когато на екрана на устройството се появява съобщението „AP“, това означава, че безжичният модул на климатика е активирал модул „AP“.

Забележка:

Има два метода да завършите конфигурирането на мрежата:

- Конфигуриране на мрежата чрез Bluetooth сканиране.
- Конфигуриране на мрежата чрез избор на типа устройство.

Конфигуриране на мрежата чрез Bluetooth сканиране

Забележка: уверете се, че е активна функцията Bluetooth на Вашето мобилно устройство.

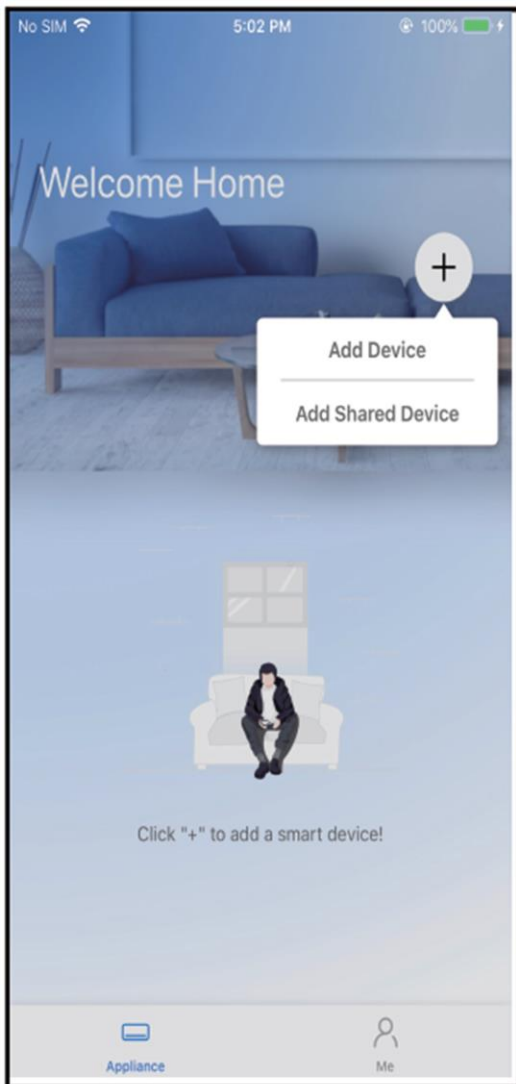

1. Докоснете бутона „+ Add device“.

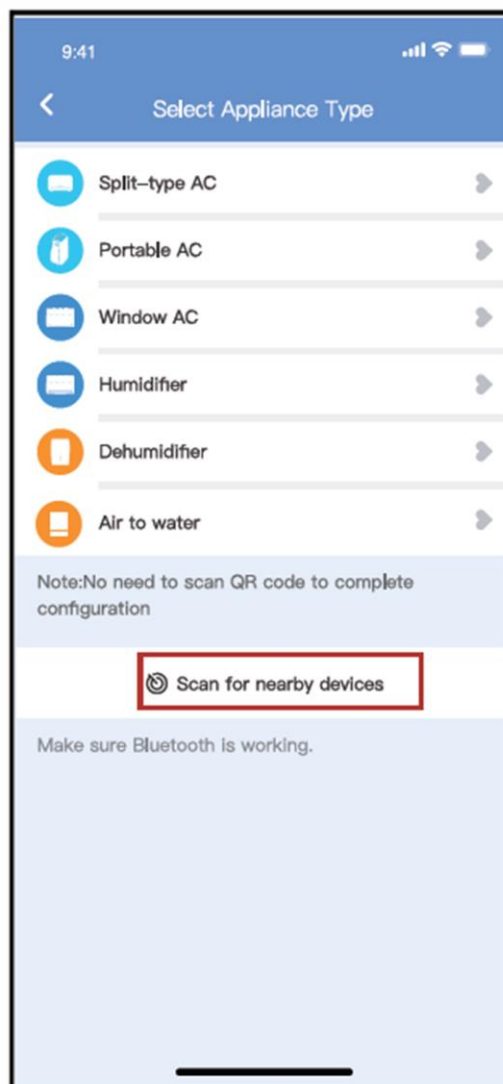

2. Докоснете бутона „Scan for nearby devices“.

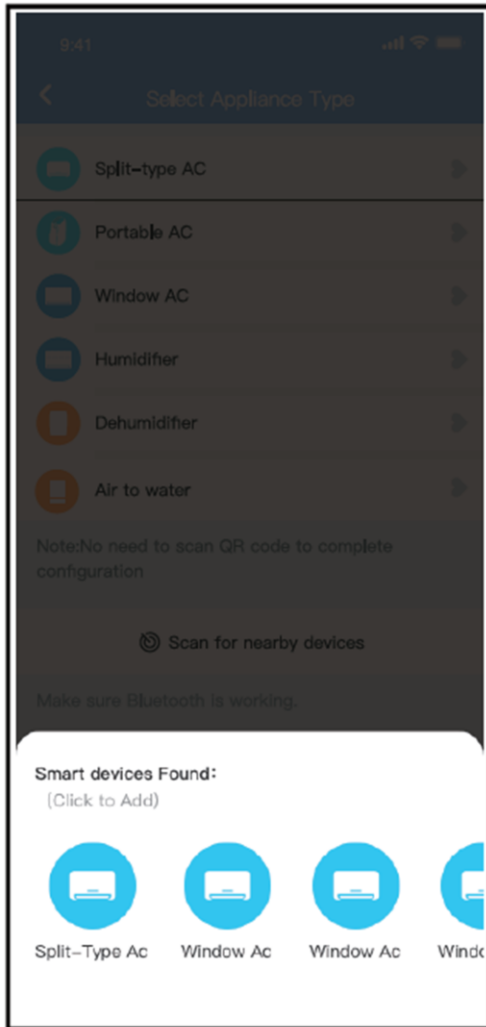

3. Изчакайте докато бъдат открити смарт устройствата, след което докоснете съответстващата пиктограма за желаното устройство.

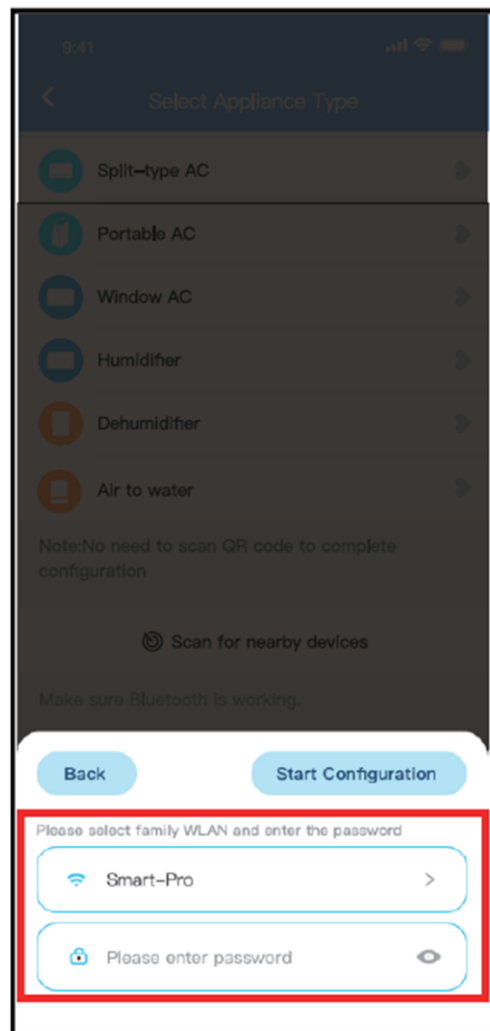

4. Изберете Wi-Fi мрежата, след което въведете паролата.

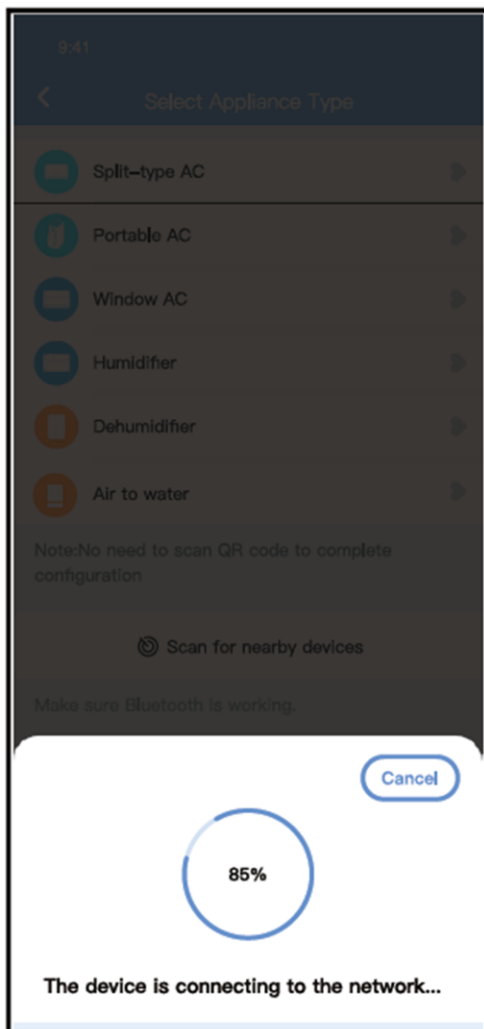

5. Изчакайте, докато се свържете към мрежата.

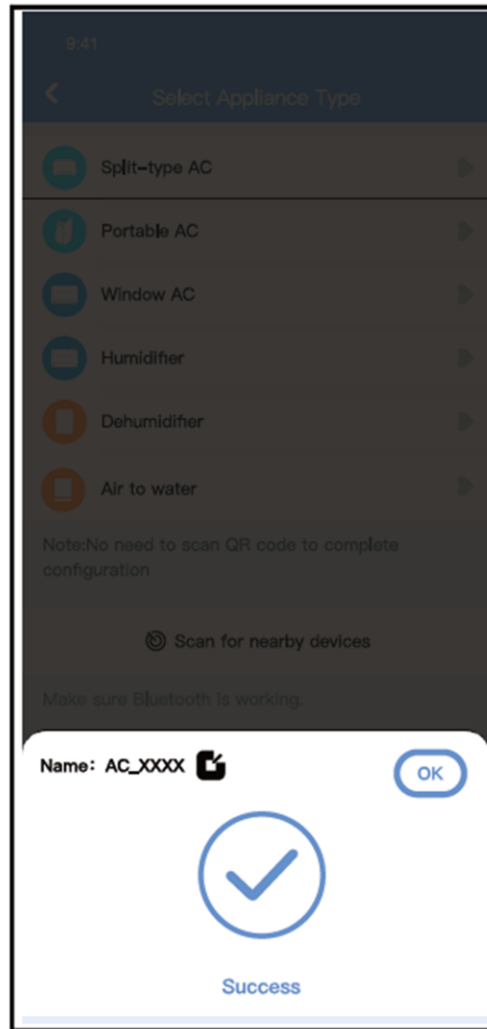

6. Конфигурирането е завършено; може да промените наименованието по подразбиране.



7. Може да изберете съществуващо или ново наименование.

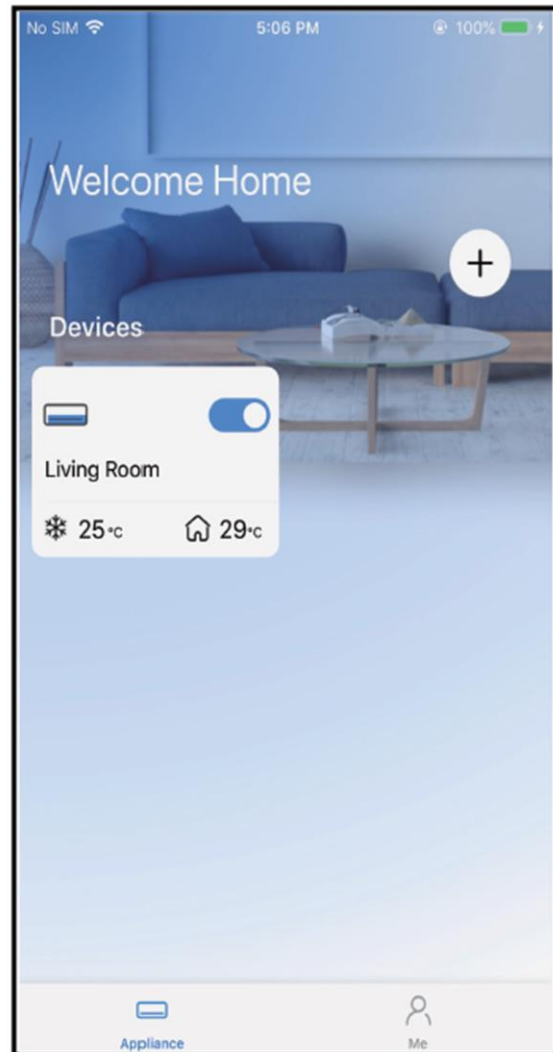

8. Конфигурирането на мрежата чрез Bluetooth е завършено; може да видите устройството в списъка.

Конфигуриране на мрежата чрез избор на типа устройство

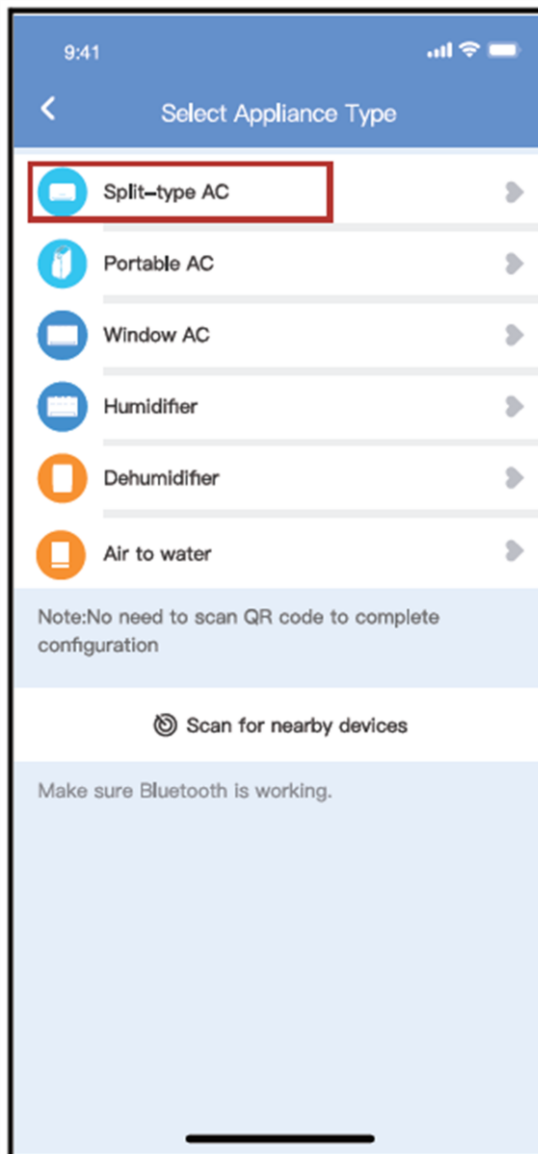

1. Ако не е успешно конфигурирането на мрежата чрез Bluetooth, моля, изберете типа устройство.

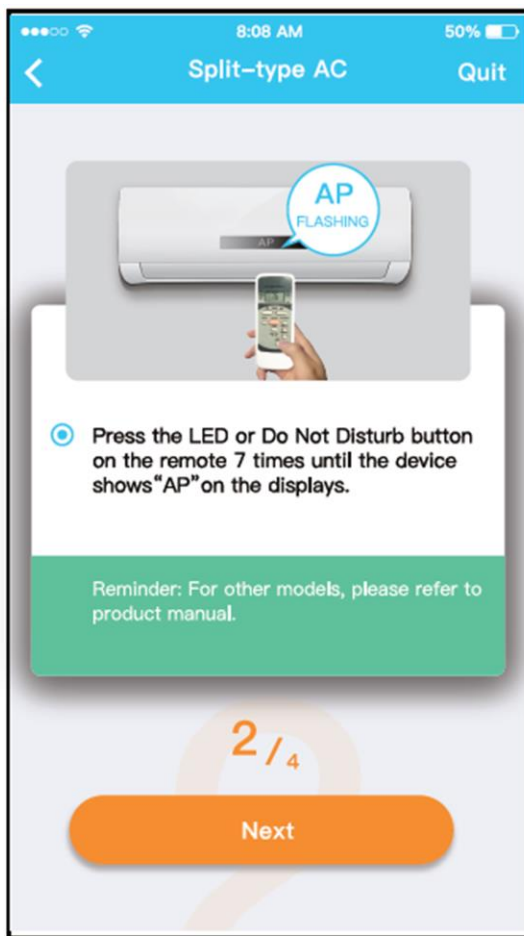
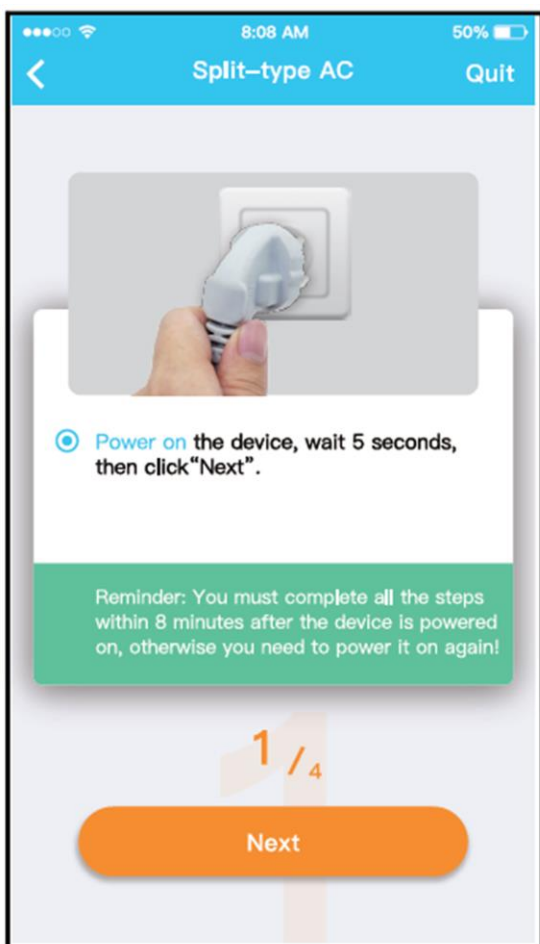

2. Моля, следвайте стъпките по-долу, за да активирате режима „AP“.

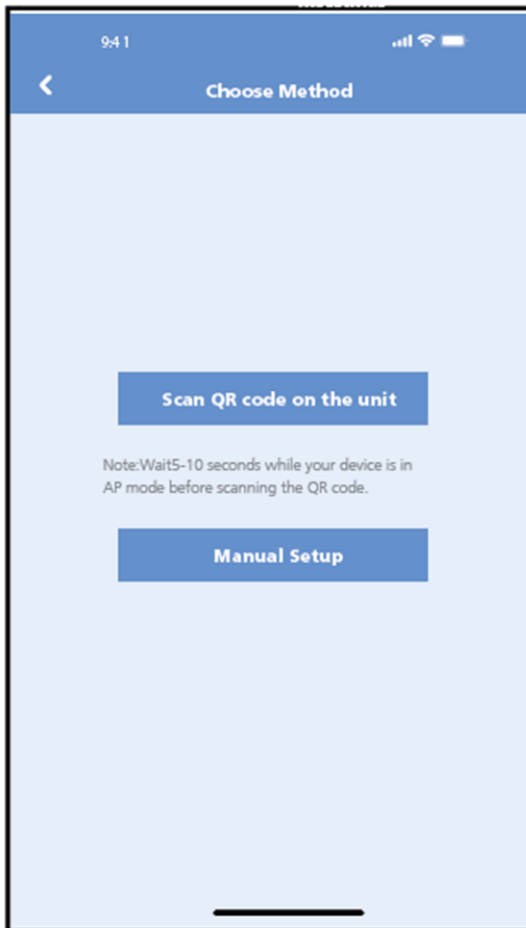

3. Изберете метода за конфигуриране на мрежата.

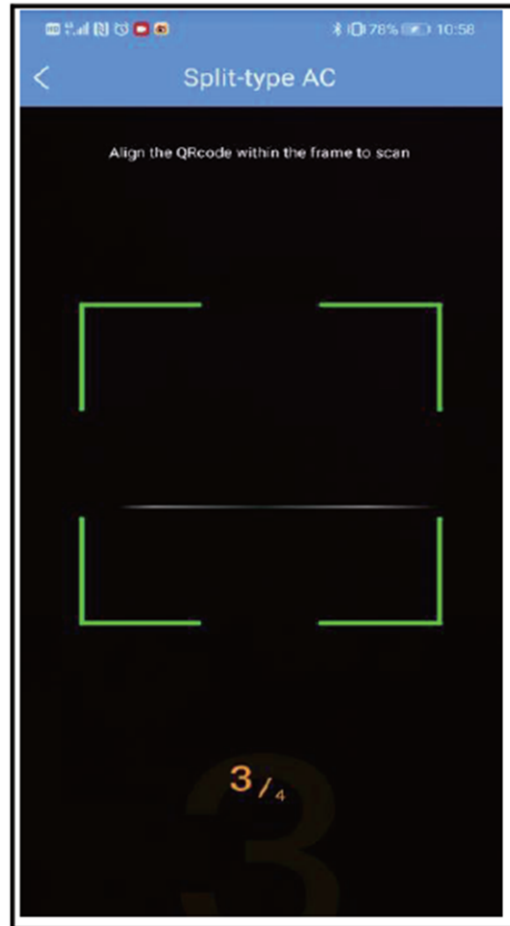

4. Изберете метода „Scan QR code“.

Забележка: Стъпките 3 и 4 са приложими само за операционната система Android. Тези две стъпки не са необходими за операционната система iOS.



5. Изберете метода „Manual setup” (Android). Свържете устройството към безжичната мрежа (iOS).

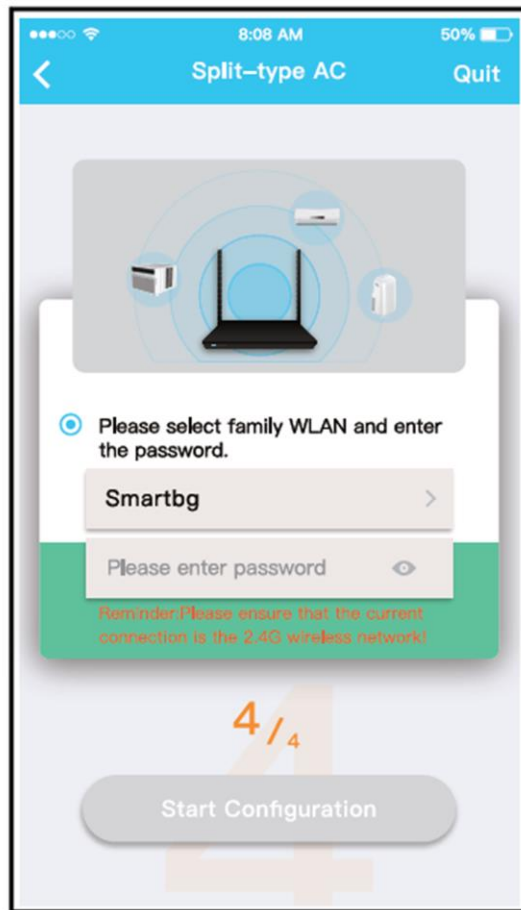

6. Моля въведете паролата си.

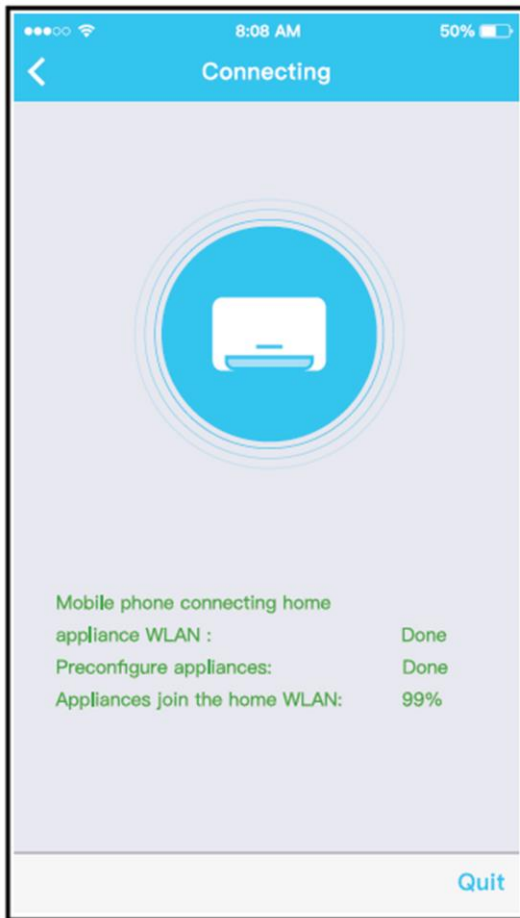

7. Конфигурирането на мрежата е успешно.

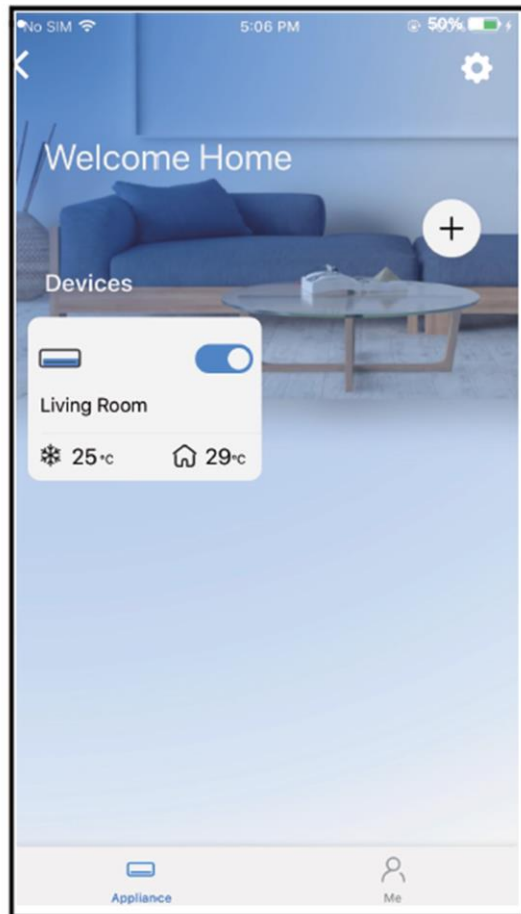

8. Конфигурирането е успешно, а устройството ще се появи в списъка.

Забележка:

- След приключване на конфигурирането на мрежата, приложението ще покаже на екрана съобщения за потвърждаване на конфигурирането.
- Поради специалните ситуации, които могат да съществуват по време на използване на връзката към Интернет, възможно е състоянието на устройството да бъде посочено като "offline". В този случай, е необходимо да опресните списъка с устройства в приложението и да се уверите, че състоянието на устройството е онлайн. Алтернативно, можете да изключите устройството от източника на захранване и да го свържете отново, а състоянието на устройството ще стане „онлайн“ след няколко минути.

VI. ИНСТРУКЦИИ ЗА ИЗПОЛЗВАНЕ НА ПРИЛОЖЕНИЕТО

Преди да използвате приложението за контролиране на климатика чрез Интернет, моля уверете се, че мобилното устройство и климатикът са свързани към Интернет.

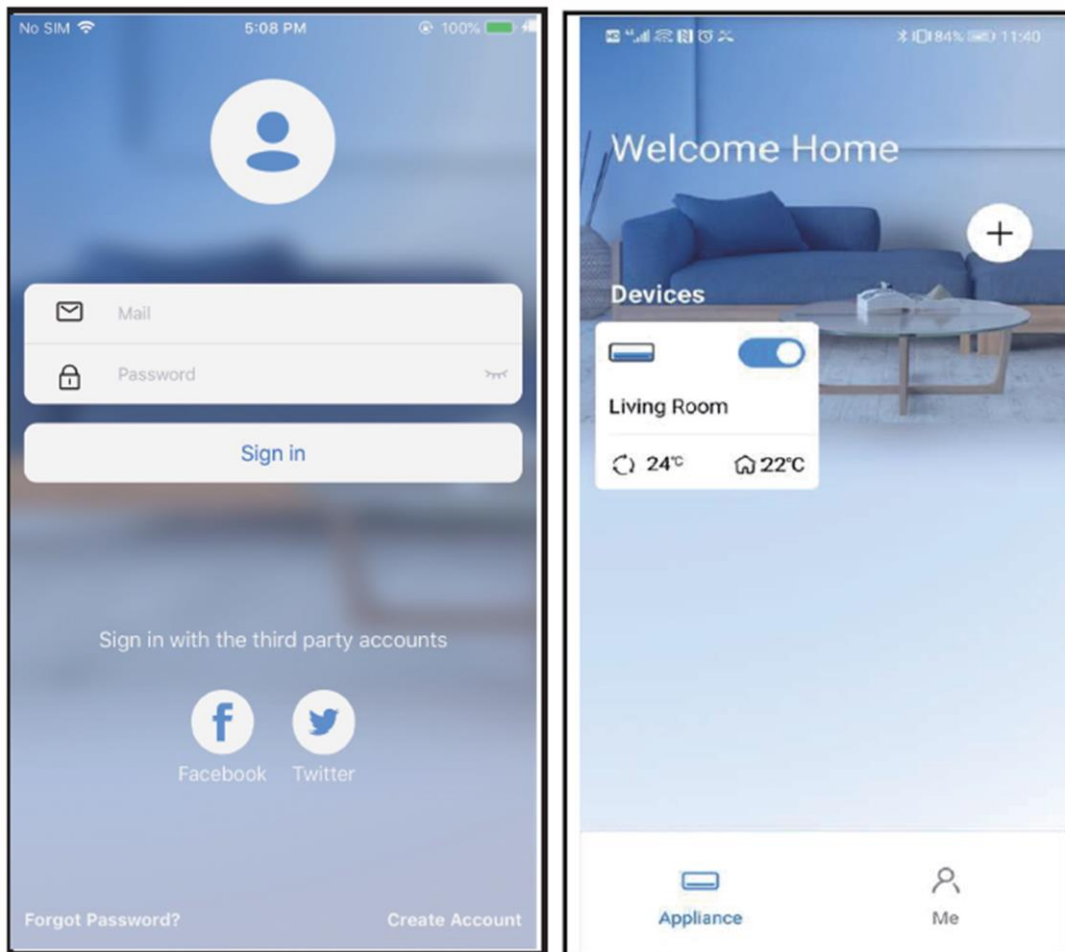

1. Докоснете бутона „Sign in”

2. Изберете климатика

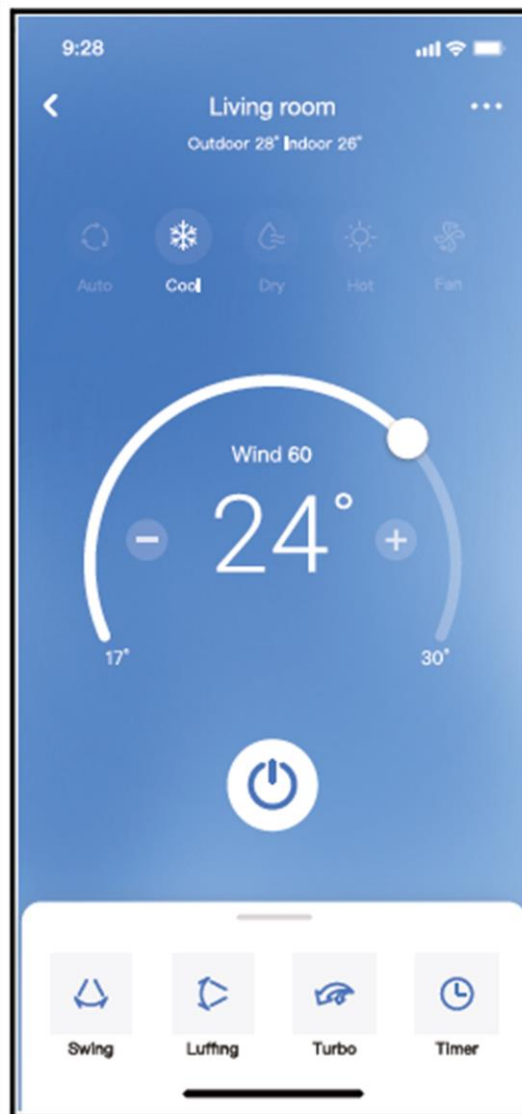

3. По този начин потребителят може да контролира включването / изключването на климатиците, режима на работа, температурата, скоростта на вентилатора и т.н.

Забележка:

Не всички функции на приложението са налични за управление на климатика. Например функциите ECO, Turbo, Swing. Вижте наръчника за употреба за повече информация.

Функция „Schedules” (Програмиране)

Седмично, потребителят може да програмира включването или изключването на климатика в определен час. Също така, потребителят може да контролира седмичната работа на климатика.

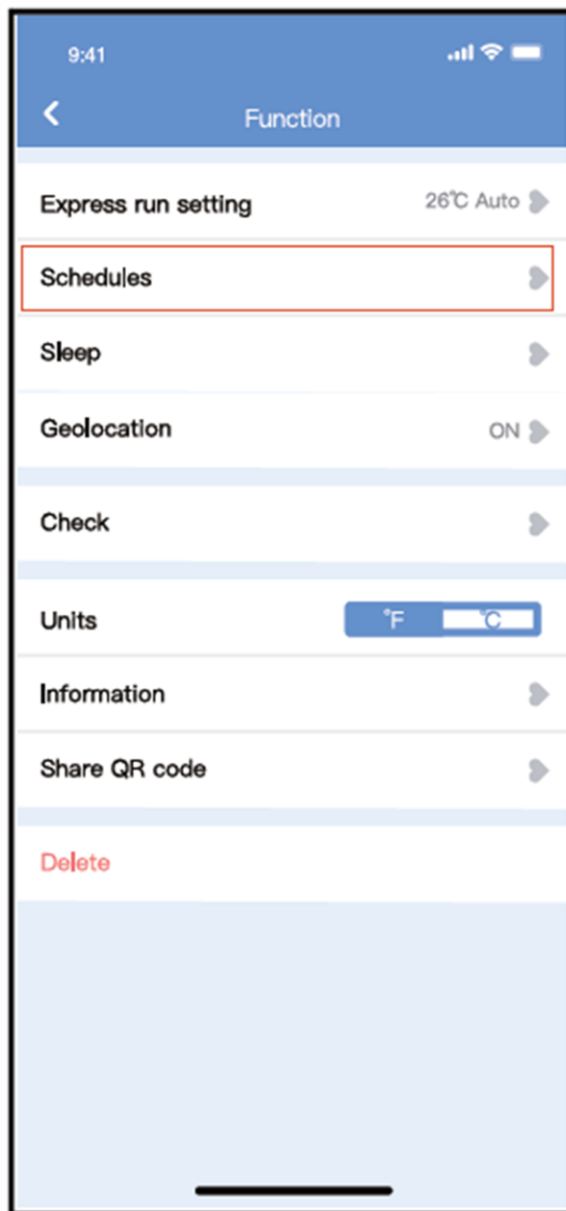

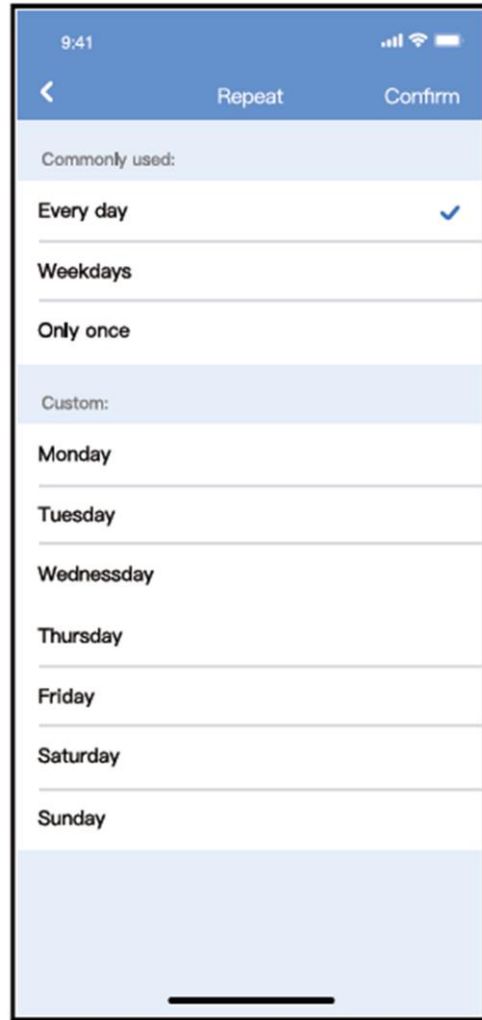
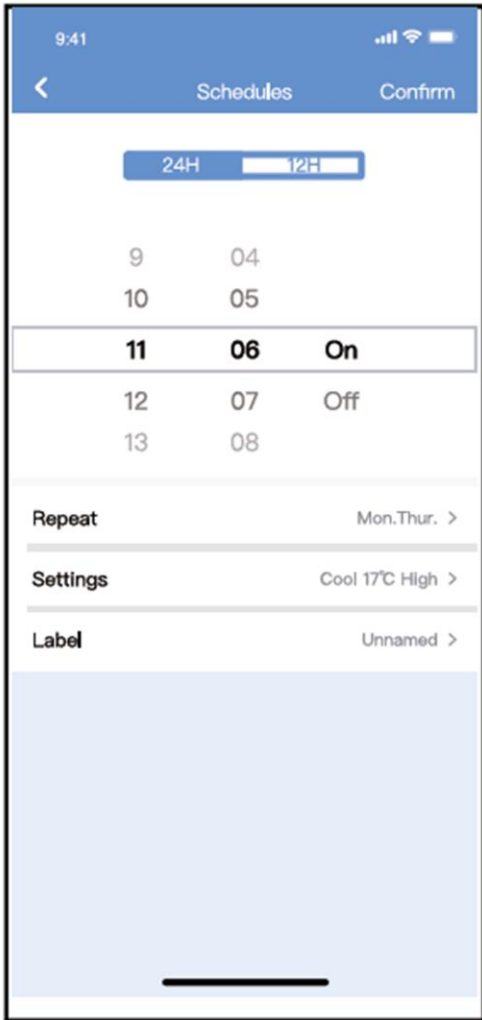

Функция Sleep (Сън)

Потребителите могат да конфигурират температурата за комфортен сън.

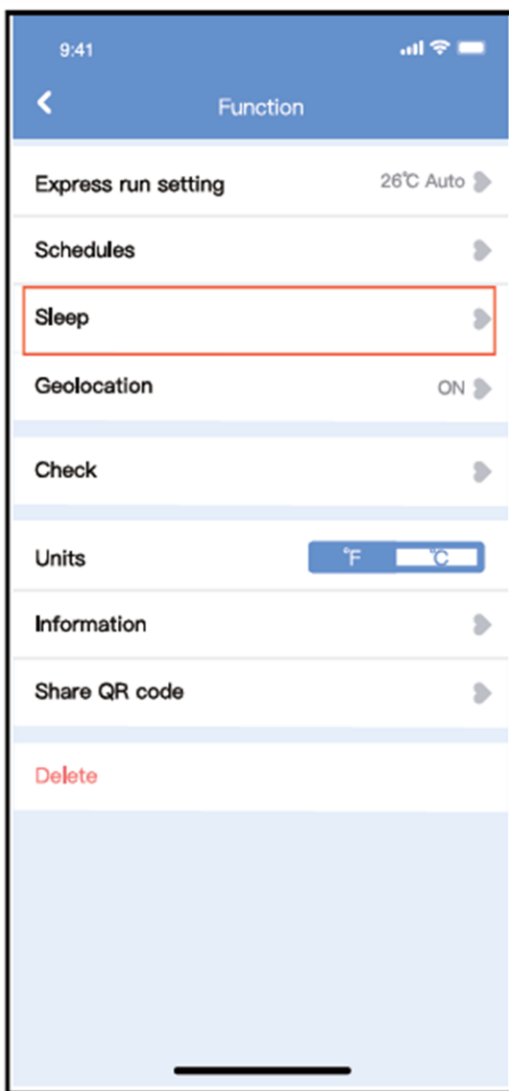

Функция Check (Проверка)

С помощта на тази функция, потребителят може да проверява работното състояние на климатика. След приключване на операцията за проверка могат да бъдат показани проблемите при работа на климатика и подробна информация.

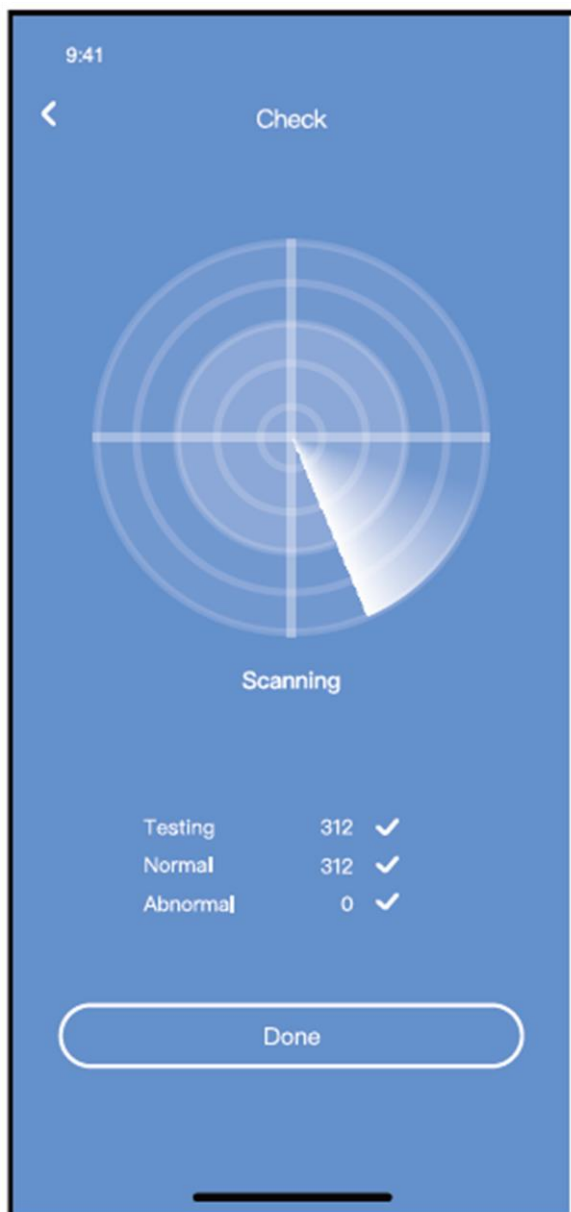

Споделяне на устройството

Климатикът може да се контролира едновременно от повече потребители чрез функцията „Share Device” (Споделяне на устройството).



1. Докоснете бутона „Shared QR code”



2. Показва се QR кодът.

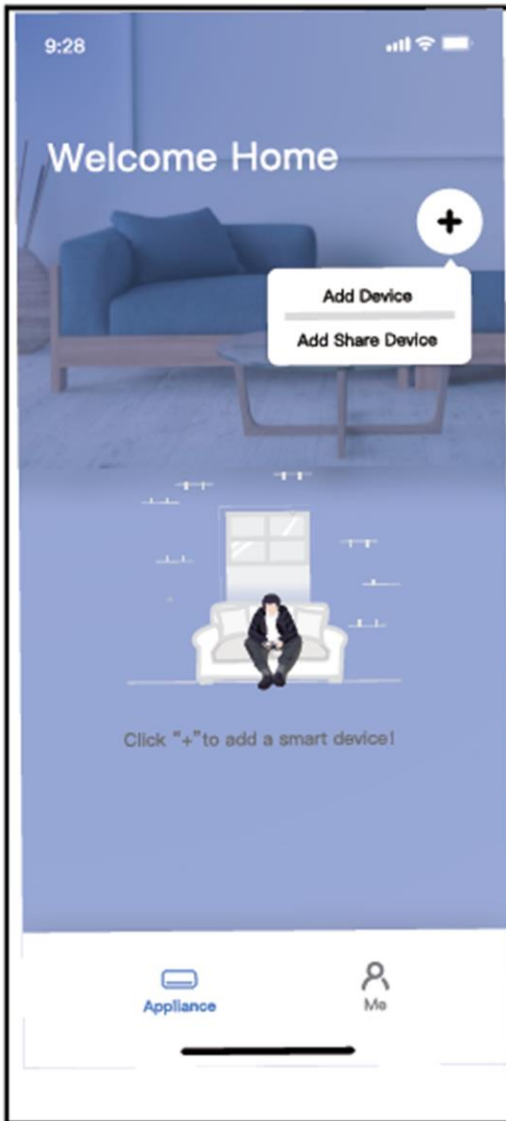

3. Другите потребители първо трябва да се свържат в приложението „Nethome Plus“, да докоснат бутона „Add Share Device“ на мобилното си устройство, а след това да сканират QR кода.

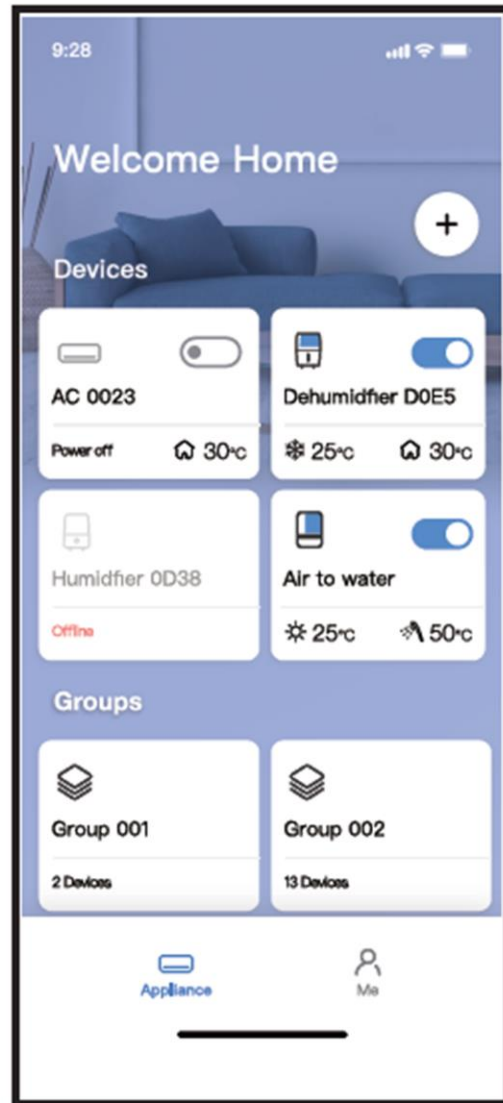

4. След това потребителите могат да добавят споделеното устройство.

Предпазни мерки:

За модели US-OSK105, EU-OSK105:

FCC ID:2AS2HMZNA21 IC:24951-MZNA21

Това устройство отговаря на част 15 от Правилата на FCC и съдържа освободени от лиценз предавател(и)/ приемник(ци), които отговарят на RSS Innovation, Science and Economic Development (Спецификациите за Радиостандарти за Иновации, Наука и Икономическо развитие), освободени от лиценз в Канада.

Работата му е предмет на следните две условия:

1. Това устройство не трябва да образува вредни смущения.
2. Това устройство трябва да приема получените смущения, включително тези, които могат да доведат до нежелателна работа.

Използвайте устройството само в съответствие с доставените инструкции.

Всякакви промени или изменения, които не са разрешени изрично от страната, която осигурява съответствието, могат да анулират правото на потребителя да използва това оборудване.

Това оборудване спазва границите за излагане на радиация, определени от FCC за неконтролирана среда. За предотвратяване на възможността за надвишаване на границите за излагане на радиация, определени от FCC, разстоянието между хората и антената трябва да е повече от 20 см по време на нормалното функциониране.

Забележка:

Това оборудване е тествано и се установи, че отговаря на ограниченията за цифрови устройства от Клас В, в съответствие с Част 15 от Правилата на FCC. Тези ограничения са замислени така, че да осигурят адекватна защита срещу вредни смущения в случай на домашна инсталация. Това оборудване генерира, използва и може да излъчва радиочестотна енергия и, ако не е инсталирано и използвано в съответствие с инструкциите, може да причини вредни смущения в радио комуникациите. Въпреки това, няма гаранция, че няма да възникнат смущения в конкретна инсталация. Ако това оборудване образува смущения, които са вредни за радио или телевизионно приемане, като това може да бъде определено чрез включване и изключване на оборудването, потребителят се съветва да опита да коригира явлението на смущение чрез една или повече от следните мерки:

- преориентиране или преместване на приемащата антена;
- увеличаване на разстоянието между продукта и приемника;
- свързване на продукта към контакт, който е част от верига, различна от тази, към която е свързан приемникът;
- консултиране с дистрибутора или квалифициран радио/телевизионен техник, с оглед получаване на съдействие.

Компанията не носи отговорност за проблеми и неизправности, причинени от Интернет, безжични рутери или смарт устройства. За допълнителна помощ, моля, свържете се със съответния доставчик.



Изхвърляне на отпадъците по начин, отговорен за околната среда

Можете да помогнете за опазването на околната среда!

Моля спазвайте местните разпоредби: Предайте нефункциониращото електрическо оборудване на център за събиране на отпадъци от електрическо оборудване.



HEINNER е регистрирана марка на компанията **Network One Distribution SRL**. Останалите търговски марки и наименованията на продуктите са търговски марки или регистрирани търговски марки на съответните им притежатели.

Нито една част от спецификациите не може да бъде възпроизвеждана под каквато и да е форма или средство, или използвана за получаване на производни като преводи, трансформации или адаптации, без предварителното съгласие на компанията NETWORK ONE DISTRIBUTION.

Copyright © 2013 Network One Distribution. Всички права запазени.

www.heinner.com, <http://www.nod.ro>



Този продукт е проектиран и произведен в съответствие със стандартите и нормите на Европейската общност.

Вносител: **Network One Distribution**

ул. Марчел Янку № 3-5, Букурещ, Румъния

Tel: +40 21 211 18 56, www.heinner.com , www.nod.ro

HEINNER

TELEPÍTÉSI ÉS HASZNÁLATI ÚTMUTATÓ WIRELESS ALKALMAZÁSHOZ

Modellek:

HAC-CR09KITWIFI	HAC-CR18WIFI	HAC-CO12WFN-WH	HAC-MRB12SLWIFI
HAC-CR12WIFI	HAC-CR18KITWIFI	HAC-CO12WFN-RD	HAC-MRB12WHWIFI
HAC-CR12KITWIFI	HAC-CR24WIFI	HAC-CO12WFN-SL	HAC-BP12WIFI-BK
	HAC-CR24KITWIFI	HAC-CO12WFN-GD	HAC-CLS12WHWIFI

MEGFELELŐSÉGI NYILATKOZATOK

Ezennel kijelentjük, hogy ez a Wi-Fi felszerelés megfelel a 2014/53/EU sz. Irányelv által támasztott elvárásoknak és a további vonatkozó előírásoknak.

JELLEMZŐK

Modell: EU-OSK105, US-OSK105

Szabvány: IEEE 802.11b/g/n

Antenna típus: körsugárzó külső antenna

Frekvenciasáv: 2400 - 2483,5 MHz

Működési hőmérséklet: 0°C~45°C/32°F~113°F

Megengedett nedvesség: 10%~85%

Bemeneti teljesítmény: DC 5V/300mA

Maximális TX teljesítmény: <20dBm

ÓVINTÉZKEDÉSEK

Operációs rendszerek: iOS, Android

- Kérjük, hogy tartsa az alkalmazást a legújabb verzióra frissítését.
- Mivel adottak az olyan különleges körülmények, amelyek felléphetnek az alkalmazás során, kifejezetten kihangsúlyozzuk a következőket: Nem mindenik Android és iOS rendszer kompatibilis az alkalmazással. Nem vállalunk felelősséget az összeférhetetlenségből adódó gondokért.

A wireless eszköz biztonsága

A Wi-Fi készlet csak a WPA-PSK/WPA2-PSK titkosítási módszereket és a nem titkosított hálózatokat támogatja.

Javasoljuk a WPA-PSK/WPA2-PSK titkosítást.

Figyelmeztetések

- Mivel felléphetnek a hálózat használata közben bizonyos körülmények, az ellenőrzési folyamatnál problémák adódhatnak. Ebben a helyzetben megtörténhet, hogy az eszköz információi nem azonosak az alkalmazás információival.
- Az okostelefon fényképezőgépjének legalább 5 mp felbontással kell rendelkeznie a QR-kód pontos szkenneléséhez.
- Mivel felléphetnek a hálózat használata közben bizonyos körülmények, előfordulhat, hogy lejár a kérés várakozási ideje (request timeout), amely megköveteli a hálózat újrakonfigurálását.
- A termék funkcióinak javítása érdekében, az alkalmazás előzetes értesítés nélkül képezheti a frissítés tárgyát. A tulajdonképpeni hálózat beállítási eljárás kissé eltérhet a kézikönyvben feltüntetettől.

II. AZ ALKALMAZÁS LETÖLTÉSE ÉS TELEPÍTÉSE

Figyelem: Az alábbi QR kód csak az alkalmazás letöltéséhez áll rendelkezésre. Ez teljes mértékben különbözik a Wi-Fi készleten használt QR kódtól.



Android



iOS

- Android telefon felhasználók: szkennelje be a QR kódot vagy nyissa meg a Google Play-t, keresse meg a „NetHome Plus” alkalmazást és töltsse le.
- iOS telefon felhasználók: szkennelje le a QR kódot vagy nyissa meg az App Store-t, keresse rá a „NetHome Plus” alkalmazást és töltsse le.

III. WIFI EGYSÉG BESZERELÉSE (VEZETÉK NÉLKÜLI/WIRELESS MODUL)

1. Távolítsa el a Wi-Fi készlet (wireless modul) védőburkolatát.
2. Nyissa ki a homlokzati panelt és helyezze be a Wi-Fi készletet a speciális csatlakozó felületbe.
3. Ragassza a légkondicionáló berendezés oldalára a Wi-Fi készlettel (wireless modul) együtt forgalmazott QR kódot, mely könnyen leolvasható az okostelefonnal. Vagy a felhasználónak lehetősége van lefényképezni a QR kódot és a telefonra menteni.

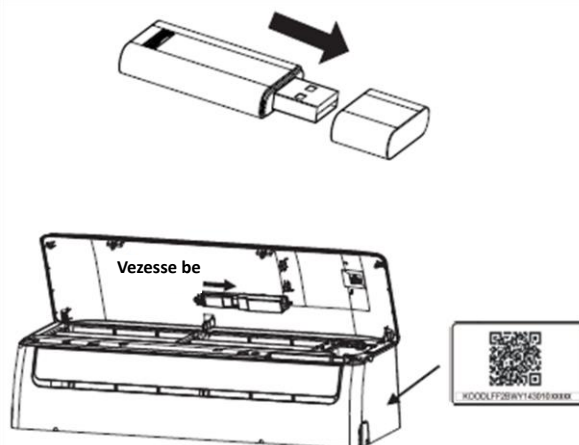

Figyelmeztetés: Ez az interfész csak a gyártó által szállított Wi-Fi-készlettel (vezeték nélküli modul) kompatibilis.

IV. FELHASZNÁLÓ REGISZTRÁLÁSA

- Kérjük, győződjön meg róla, hogy mobil készüléke csatlakoztatva van a Wi-Fi hálózathoz. Továbbá a felhasználó regisztrációja és a hálózat konfigurálása előtt a Wi-Fi routert csatlakoztassa az internethez.
- Javasoljuk, hogy lépjen be az e-mail fiókba, és aktiválja a regisztrációt a hivatkozásra kattintva a jelszó elfelejtése esetén. A felhasználói fiók használatával be tud jelentkezni.

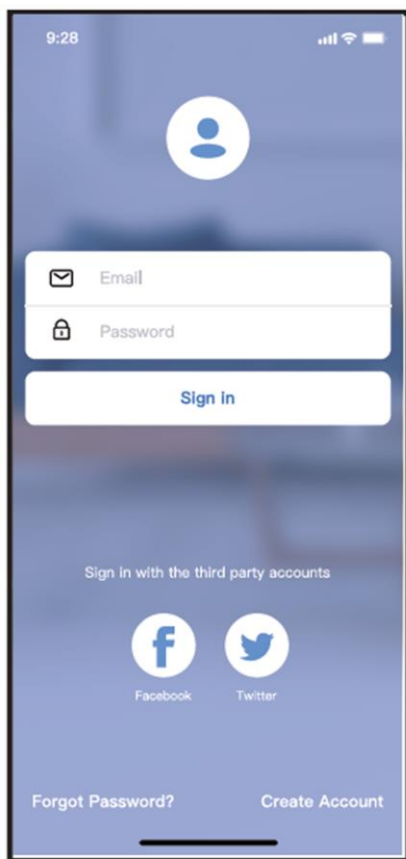

Android

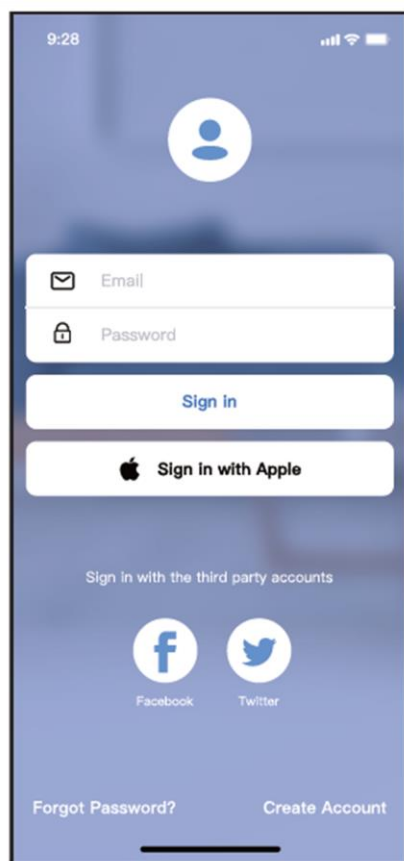

iOS

1. Érintse meg „Create Account” gombot.

9:41

Create Account

Enter your Email address

Password

Confirm Password

Password need 6-20 characters, must contain letters and numbers.

Register

I have read and agree to the terms and privacy

2. Adja meg e-mail címét és jelszavát, majd érintse meg a „Register” gombot.

Óvintézkedések:

- Szükséges a régióban található más Wi-Fi hálózatok törlése és annak biztosítása, az Ön IOS vagy Android készüléke ahhoz a Wi-Fi hálózathoz csatlakozik, melyet konfigurálni kíván.
- Ellenőrizze, hogy az iOS vagy Android mobilkészülék Wi-Fi funkciója aktív, és hogy a mobilkészülék automatikusan újra tud csatlakozni a Wi-Fi hálózathoz.

Kérjük, jegyezze meg:

A felhasználónak a légkondicionáló berendezés bekapcsolásától számított 8 perc alatt végig kell csinálnia minden lépést. Ellenkező esetben a berendezést újra kell indítani.

Android vagy iOS eszköz használata a hálózat beállításához

- Győződjön meg róla, hogy az Ön mobilkészüléke már csatlakozott a használni kívánt wireless hálózathoz. Ugyanakkor mellőzze a más wireless hálózatokat, ha azok befolyásolják a konfigurálási eljárást.
- Csatlakoztassa le a légkondicionáló berendezést az áramforrásról.
- Csatlakoztassa a légkondicionáló berendezést az áramforráshoz, majd nyomja meg a „LED DISPLAY” vagy a „DO NOT DISTURB” gombot 7-szer 10 másodperc alatt.
- Amikor a képernyőn megjelenik az „AP” jelzés, a légkondicionáló berendezés wireless modulja aktiválta az „AP” üzemmódot.

Megjegyzés:

A hálózati konfiguráció befejezésének két módszere van:

- Hálózat beállítása Bluetooth szkenneléssel.
- Hálózat beállítása az eszköz típusának kiválasztásával.

Hálózat beállítása Bluetooth szkenneléssel

Megjegyzés: Győződjön meg róla, hogy a mobilkészít Bluetooth funkciója aktív.

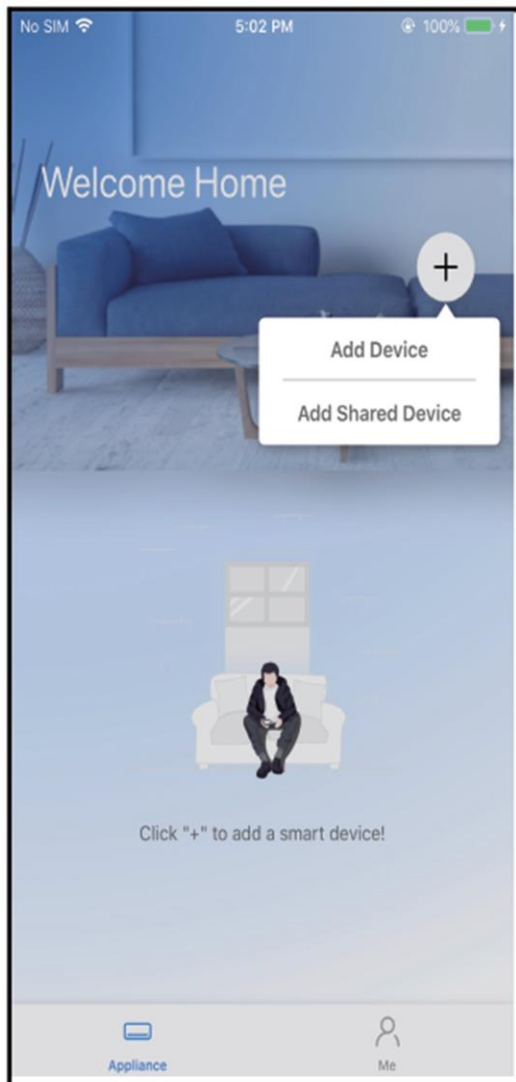

1. Érintse meg az „+ Add device”
(eszköz hozzáadása) gombot

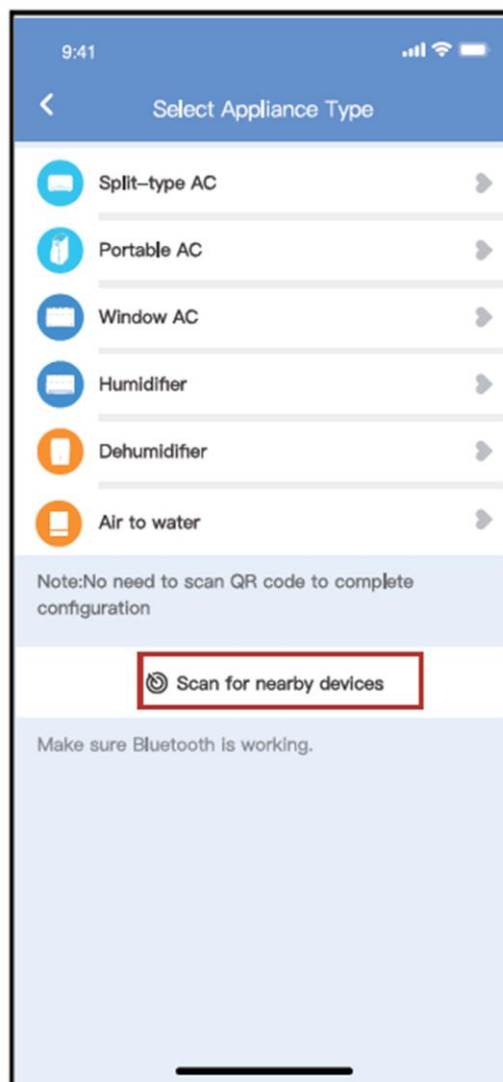

2. Érintse meg „Scan for nearby devices”
(Közelben lévő eszközök keresése)
gombot

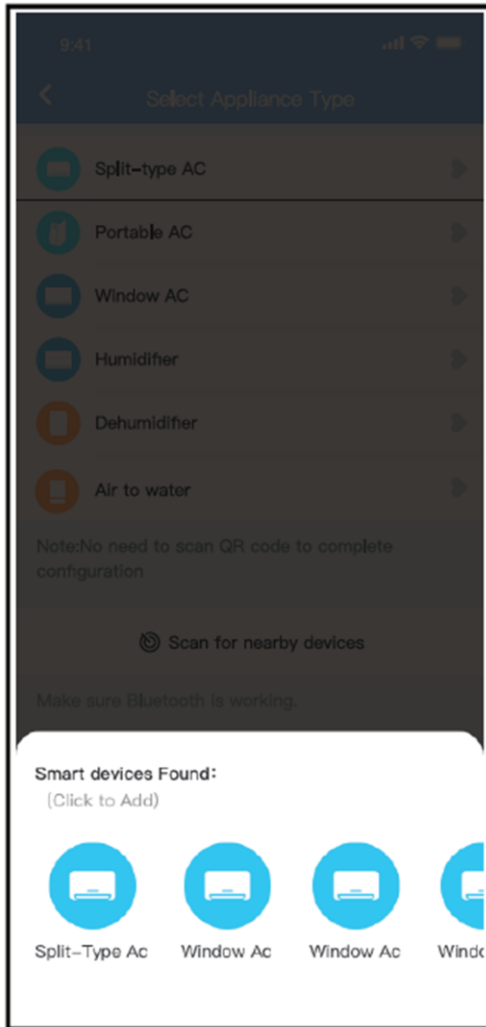

3. Várjon, amíg megtalálja az intelligens eszközöket, majd érintse meg a kívánt eszköz ikonját.

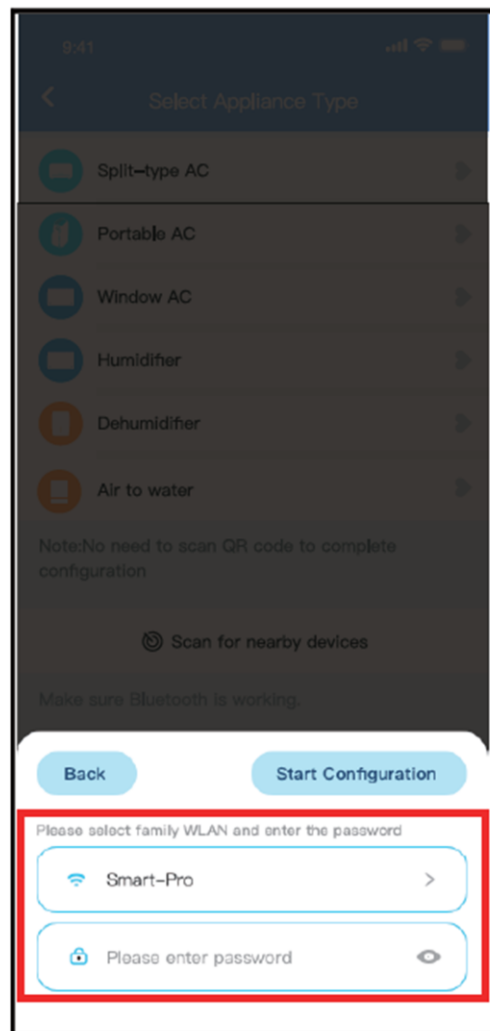

4. Válassza ki a Wi-Fi hálózatot, majd írja be a jelszót.

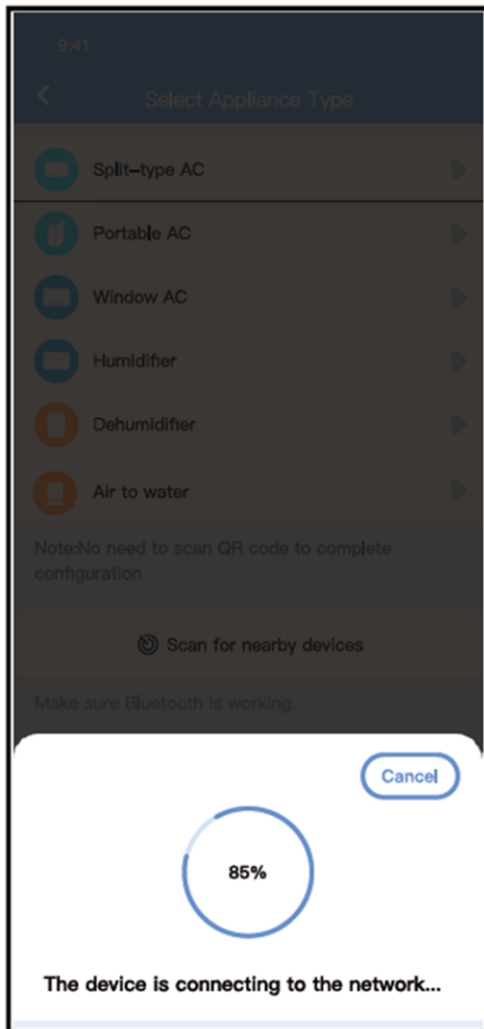

5. Várjon, amíg csatlakozik a hálózathoz.

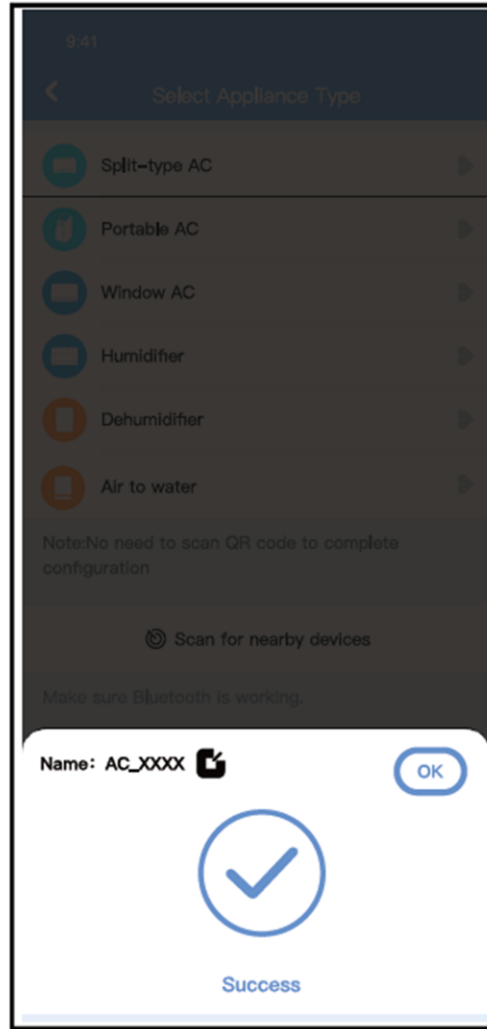

6. A konfiguráció befejeződött; megváltoztathatja az alapértelmezett nevet.



7. Kiválaszthat egy meglévő vagy egy új nevet.

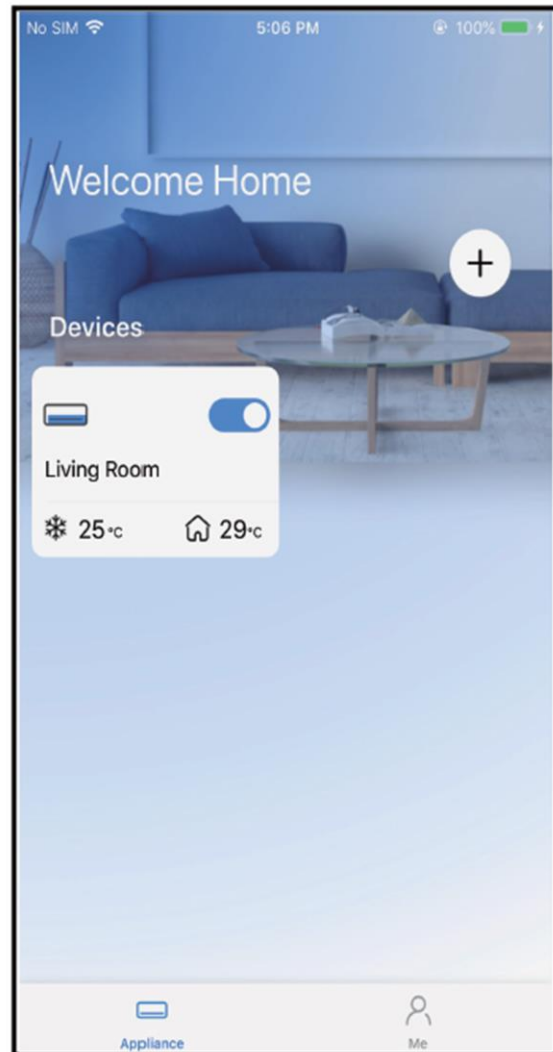

8. A Bluetooth-hálózat beállítása befejeződött; az eszköz látható a listában.

Hálózat beállítása az eszköz típusának kiválasztásával

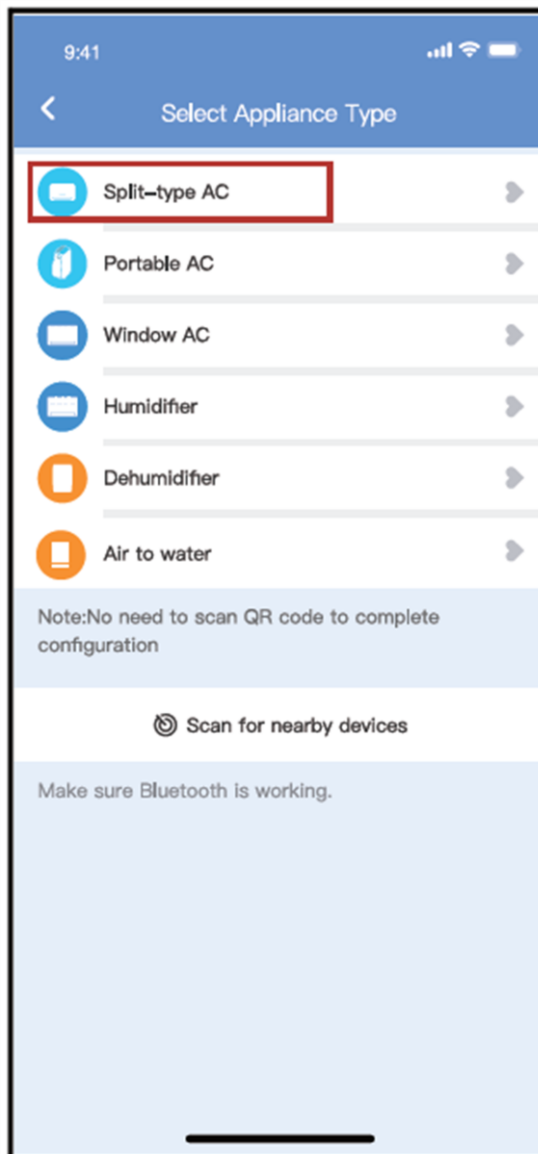

1. Ha a Bluetooth-hálózat beállítása nem sikeres, kérjük, válassza ki az eszköztípust.

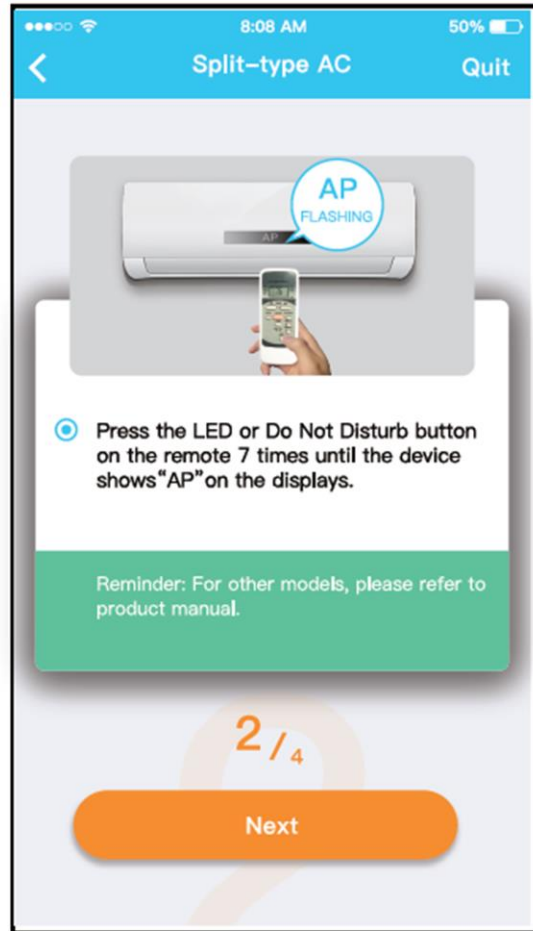

2. Kérjük, kövesse az alábbi lépéseket az „AP” üzemmód aktiválásához.

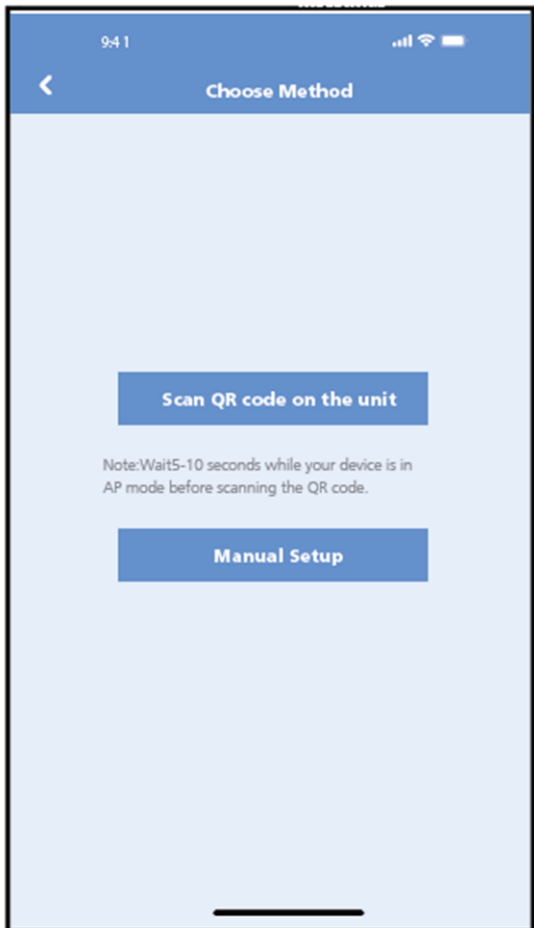

3. Válassza ki a hálózati konfigurációs módszert.

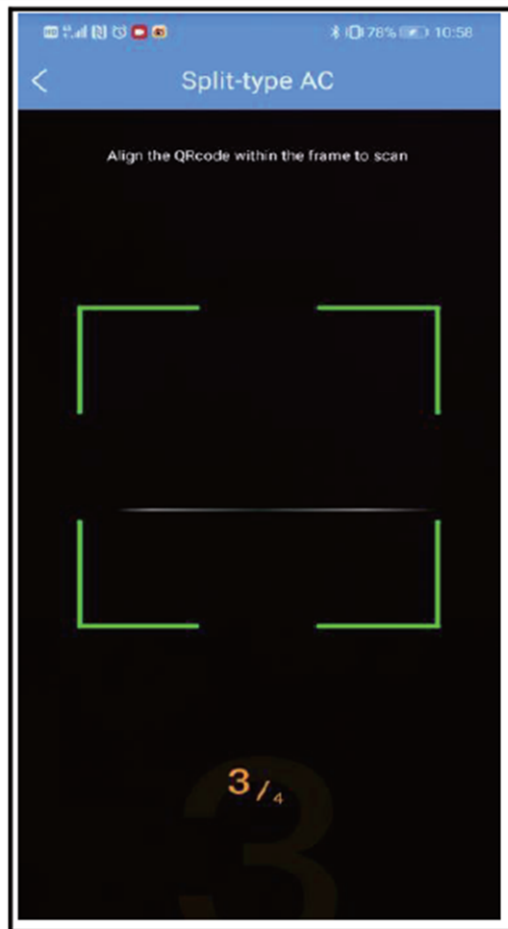

4. Válassza ki a „Scan QR code” módot.

Megjegyzés: A 3. és 4. lépés csak az Android rendszerre vonatkozik. Az iOS esetében erre a két lépésre nincs szükség.



5. Válassza a "Kézi beállítás/Manual Setup" módszert (Android). Csatlakoztassa a készüléket a vezeték nélküli hálózathoz (iOS).

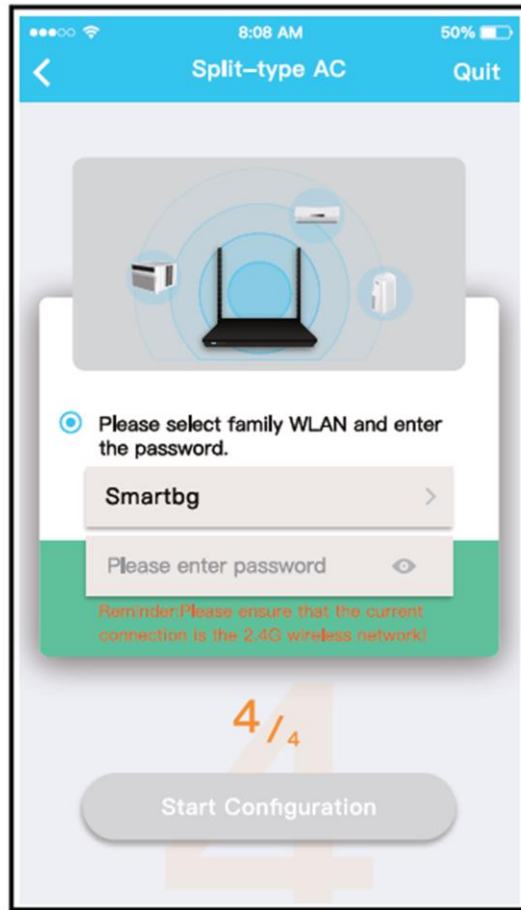

6. Kérjük, írja be a jelszót.

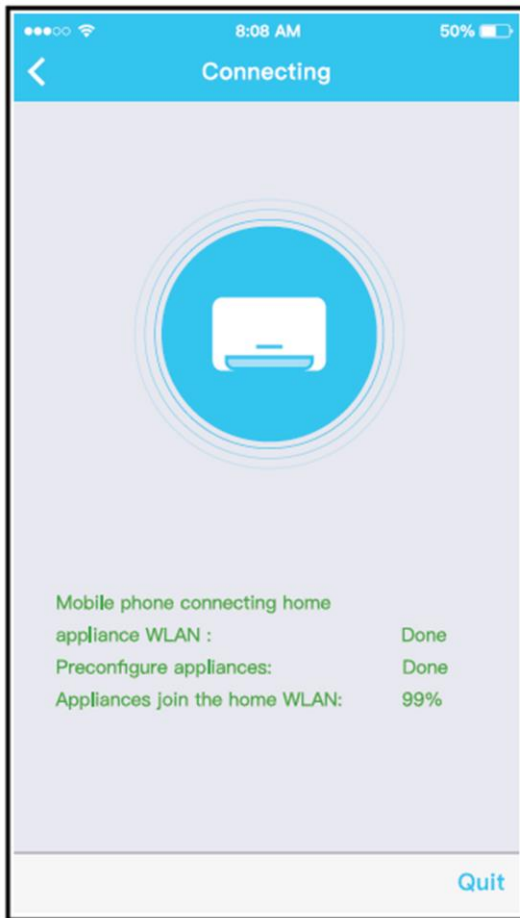

7. A hálózat konfigurálása sikerült.

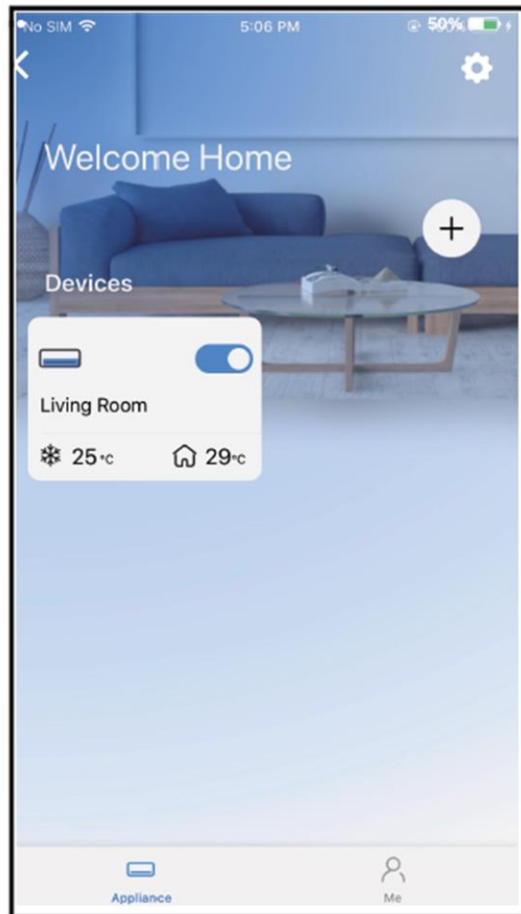

8. A konfigurálás sikerült, a készüléket, a készülék megjelenik a listában.

Megjegyzés:

- A hálózat konfigurálásának befejezése után az alkalmazás a konfigurálást megerősítő üzenetet küld a képernyőre.
- Tekintettel az internethez csatlakozás közben fellépő különleges helyzetekre, előfordulhat, hogy a készülék kijelzett állapota „offline” -ná válik. Ilyenkor frissítse az alkalmazás eszköz listáját és bizonyosodjon meg arról, hogy a készülék állapota online. Ha lecsatlakoztatja a berendezést az áramforrásról, majd újracsatlakoztatja, a berendezés állapota néhány perc múlva ismét „online” -ná válik.

VI. AZ ALKALMAZÁS HASZNÁLATÁRA VONATKOZÓ UTASÍTÁSOK

Az alkalmazás használata előtt a légkondicionáló berendezés interneten történő ellenőrzéséhez, kérjük, bizonyosodjon meg róla, hogy a mobilkészülék és a légkondicionáló berendezés csatlakoztatva van az internethez.

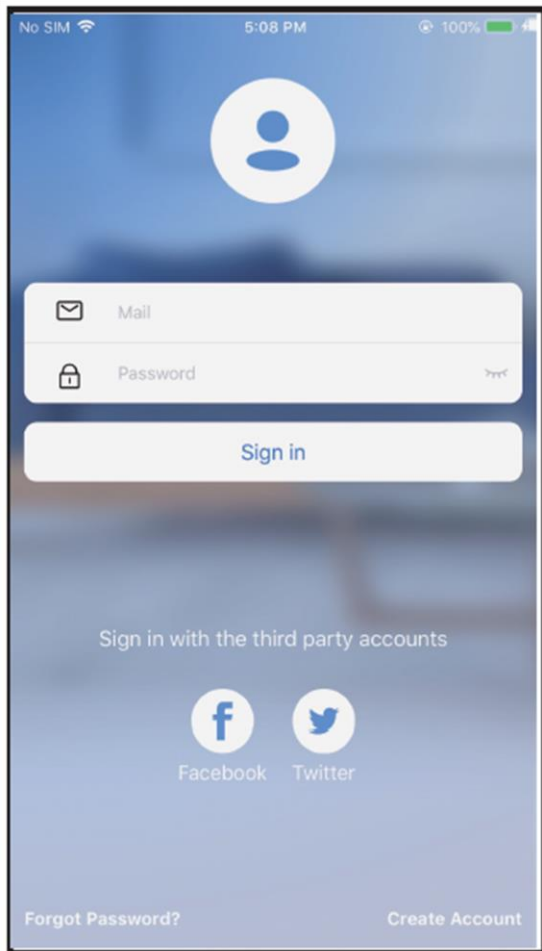

1. Nyomja meg a „Sign in” gombot.

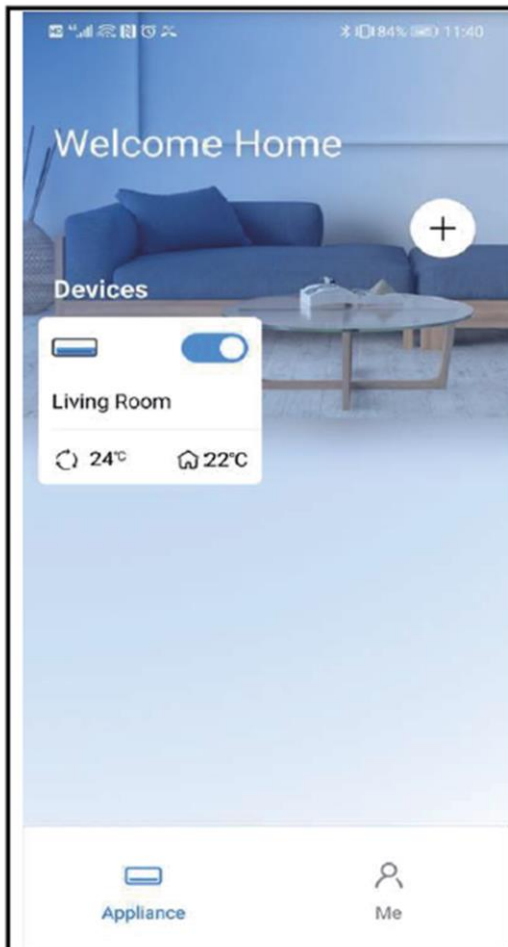

2. Válassza ki a légkondicionáló berendezést.

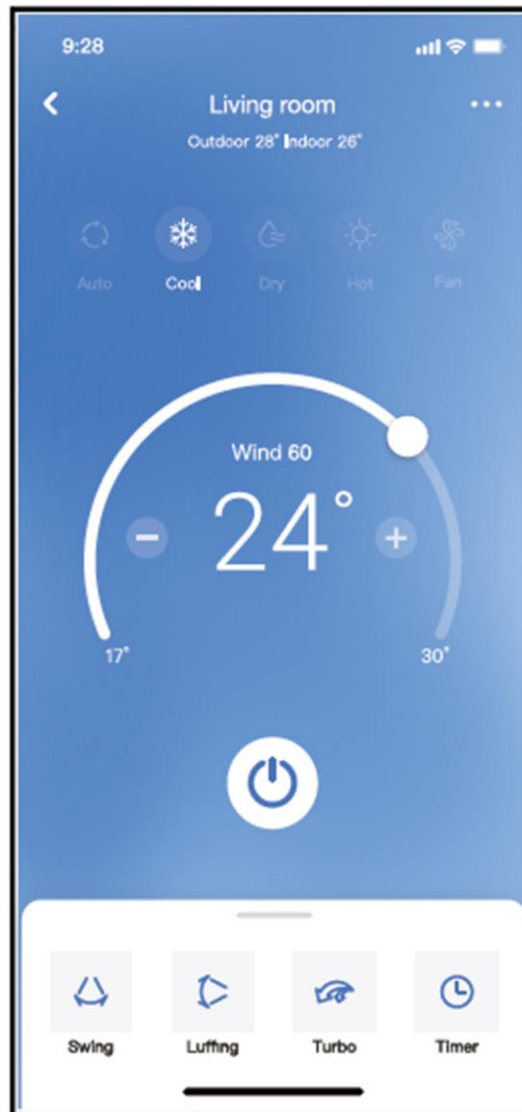

3. Így, a felhasználó ellenőrizheti a légkondicionáló berendezések indítását/leállítását, üzemelési módját, hőmérsékletét, a ventilátor sebességét és így tovább.

Megjegyzés:

Az alkalmazás nem minden funkciója érhető el a légkondicionáló vezérléséhez. Például: ECO, Turbo, Swing funkciók. További információkért lásd a felhasználói kézikönyvet.

Schedules (Programozás) funkció

Hetente a felhasználó beprogramozhatja a légkondicionáló berendezés indítását/leállítását egy adott időpontra. Ugyanakkor a felhasználó szabályozhatja a légkondicionáló berendezés heti működését.

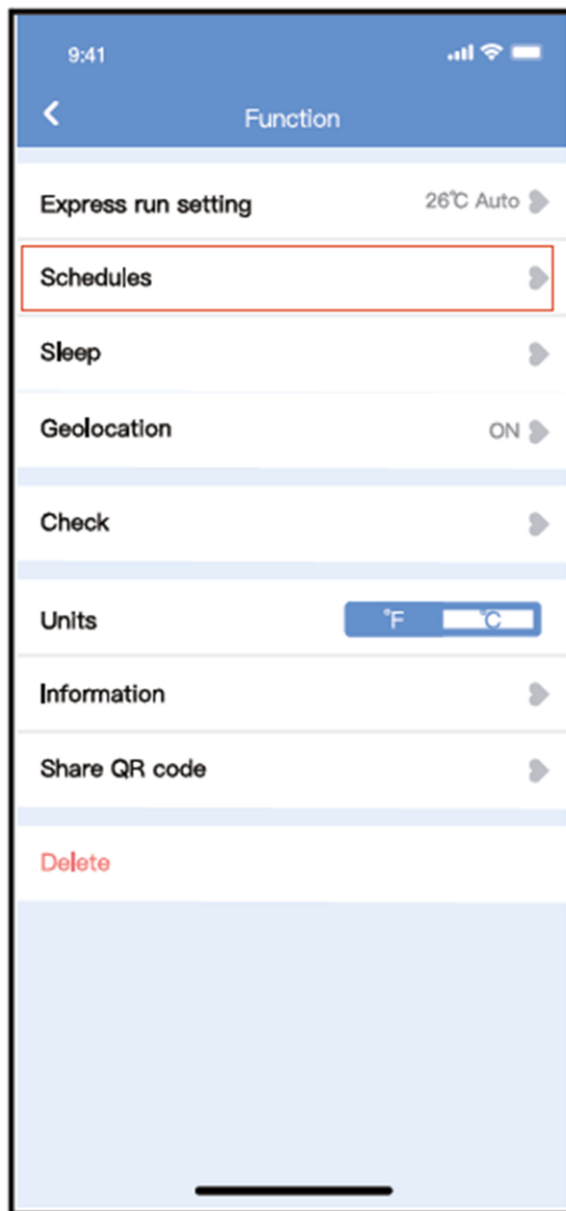

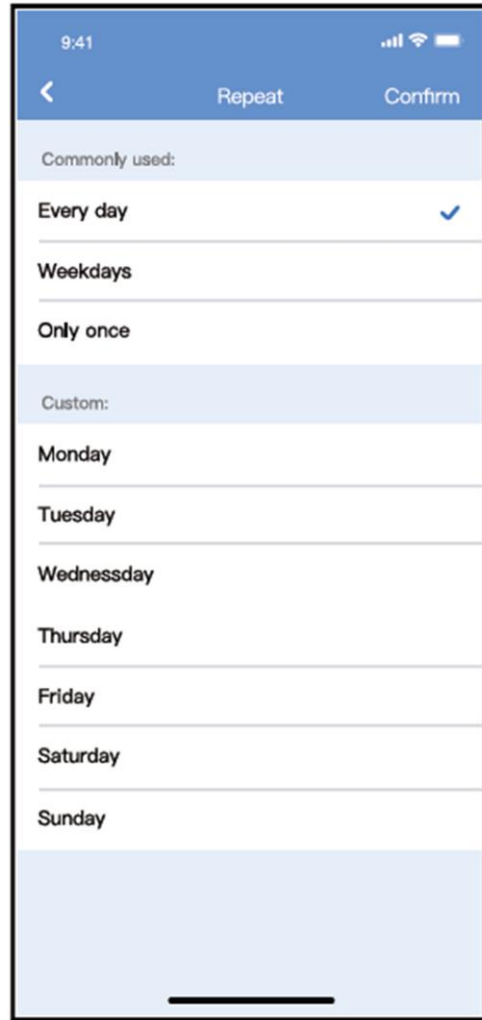
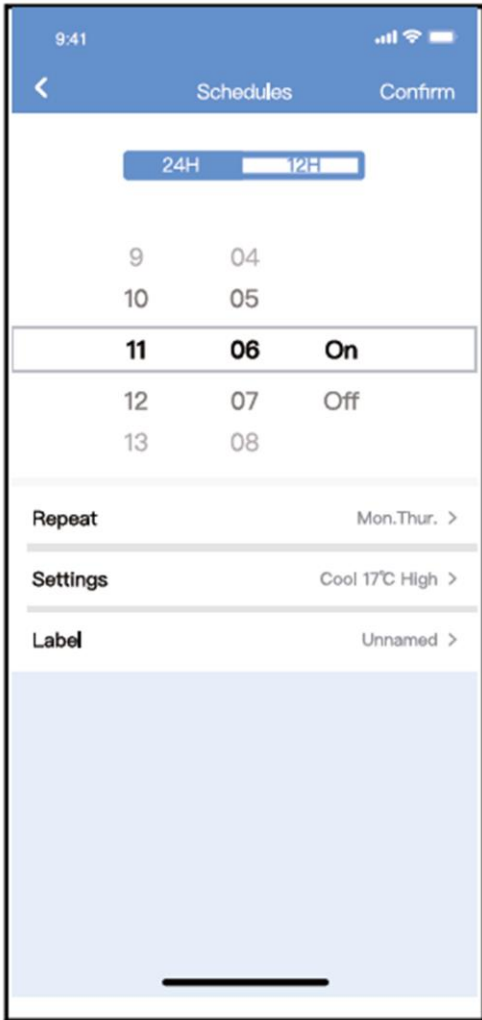

Sleep (Alvás) funkció

A felhasználó beállíthatja a hőmérsékletet a kényelmes alváshoz.

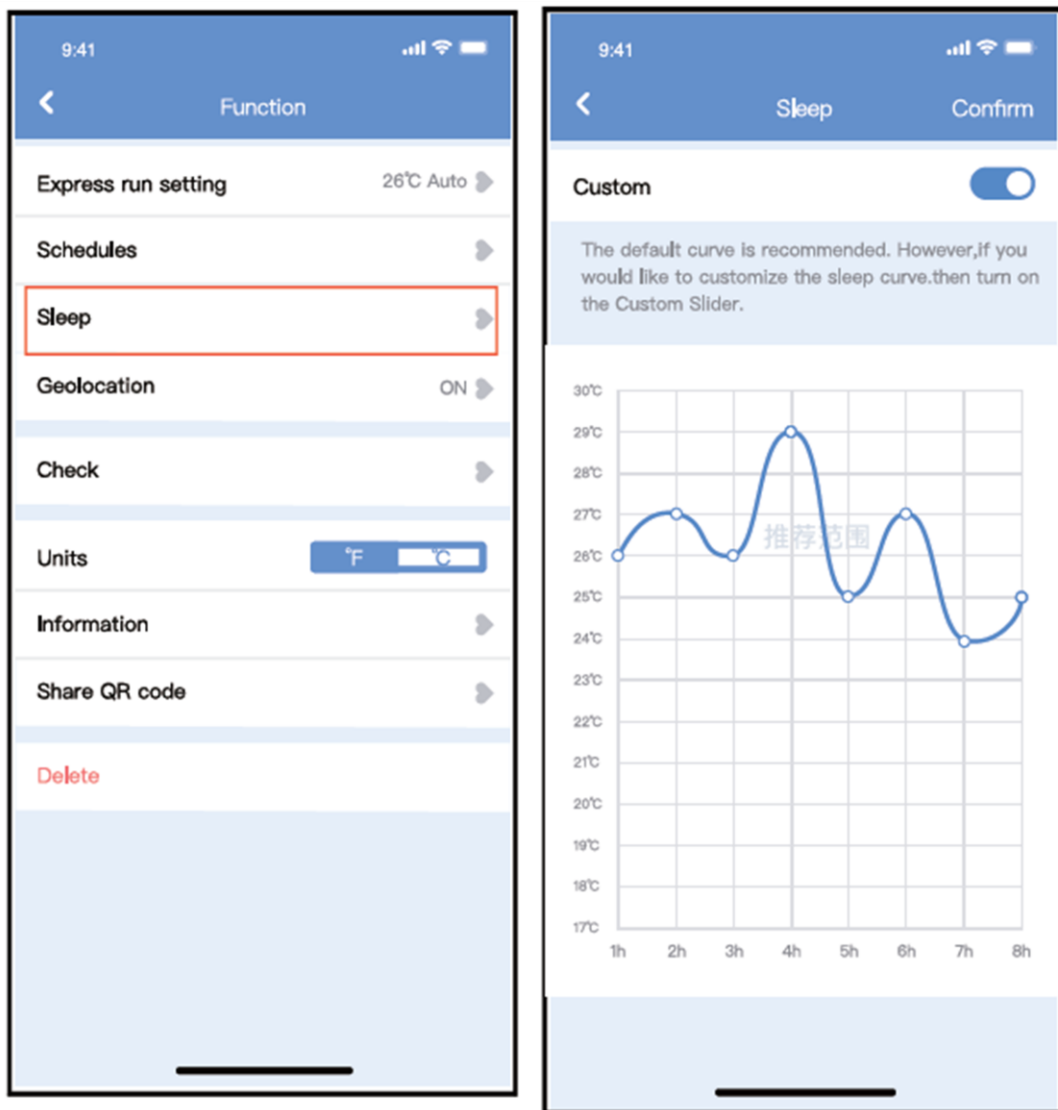

Check (Ellenőrzés) funkció

Ezzel a funkcióval a felhasználó ellenőrizheti a légkondicionáló berendezés működését. Az ellenőrzés befejezését követően, megjeleníthetők a képernyőn a működési hibák és egyéb részletes adatok.

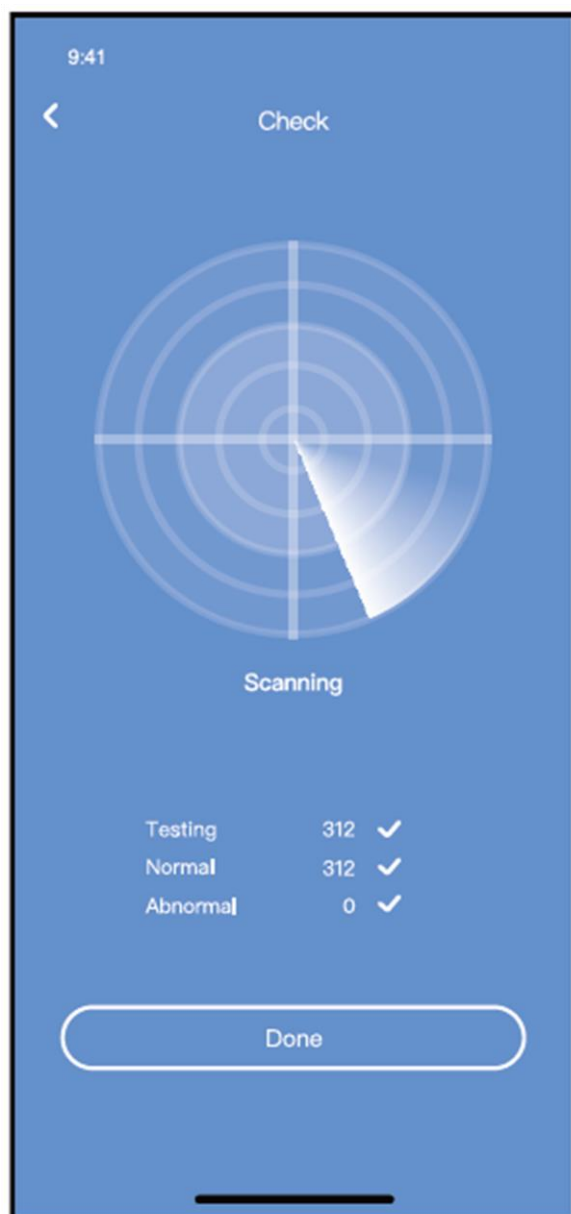

Az eszköz megosztása

A légkondicionáló berendezést a „Share Device” (eszköz megosztása) funkció segítségével egyszerre több felhasználó felügyelheti.



1. Nyomja meg a „Shared QR code” gombot.



2. Megjelenik a QR kód.

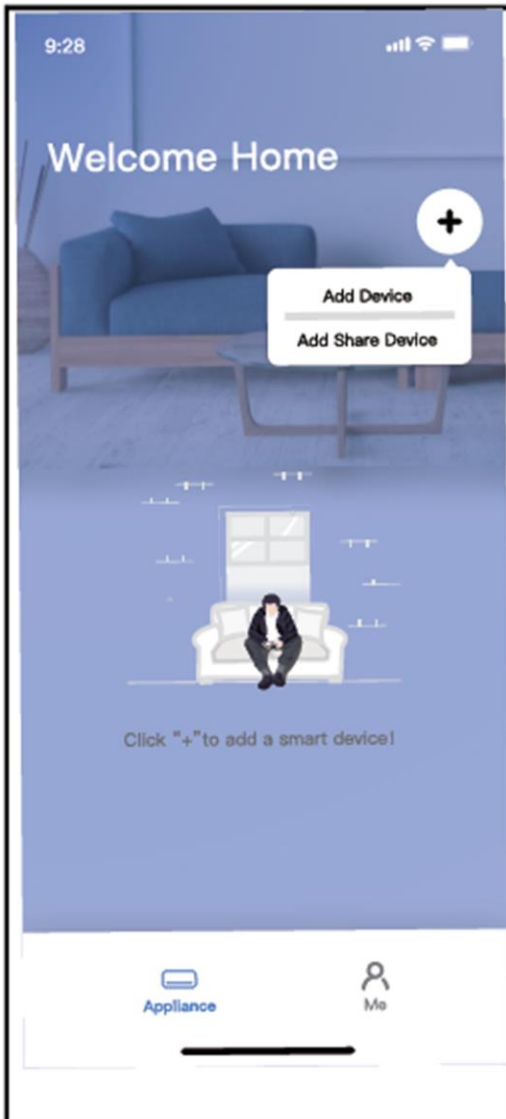

3. A többi felhasználónak először a Csatlakozzon a „Nethome Plus” alkalmazáshoz, hogy hozzáférjen a készüléken az „Add Share Device” gombhoz, majd szkennelje be a QR kódot.

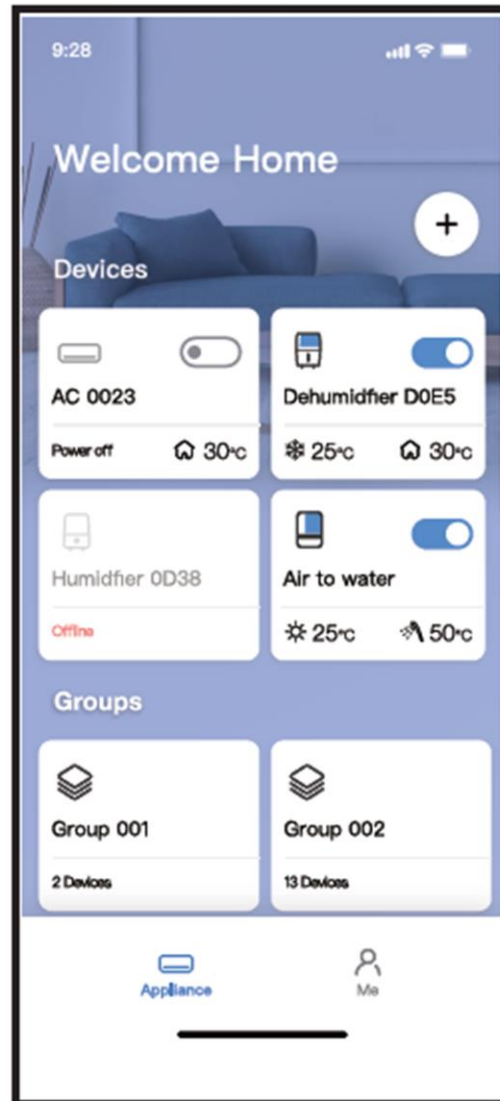

4. Majd a felhasználók hozzáadhatják a megosztott készüléket.

Óvintézkedések:

Az US-OSK105, EU-OSK105 modellek esetén:

FCC ID:2AS2HMZNA21 IC:24951-MZNA21

Ez a készülék megfelel az FCC-szabályok 15. részének, és olyan licenctmentes adó(ka)t/vevő(ke)t tartalmaz, amelyek megfelelnek az RSS Innovation, Scienceand Economic Development (Rádiószabványokra vonatkozó előírások Innováció, tudomány és gazdaságfejlesztés) kanadai licenctmentességnek.

Az üzemeltetés az alábbi két feltétel tárgyát képezi:

1. A jelen berendezés ne termeljen káros vételzavarokat.
2. A jelen berendezésnek fogadnia kell a kapott vételzavarokat, beleértve a nem kívánt üzemeléshez vezetőket is.

A készüléket csak az utasításoknak megfelelően használja.

A készülék szabványoknak való megfelelését igazoló szervezet jóváhagyása nélkül történő bármilyen természetű módosítása megvonja a felhasználónak a készülék használatára vonatkozó jogosultságát.

Ez a berendezés megfelel az FCC által, nem ellenőrzött környezetre megállapított, sugárterhelés határértékeinek. Annak érdekében, hogy elkerülje az FCC által megállapított sugárterhelés határértékének meghaladását, a távolság a személy és az antenna között nem lehet kevesebb, mint 20 cm, a normál működés során.

Megjegyzés:

Ezt a berendezést tesztelték, és azt állapították meg, hogy tiszteletben tartja a B osztályú digitális eszközre vonatkozó határértékeit az FCC szabályozások 15. fejezetének megfelelően. Ezek a határértékek úgy vannak elképzelve, hogy megfelelő védelmet biztosítson a káros interferenciák ellen egy lakó berendezésben. Ez az eszköz rádiófrekvencia energiát képes létrehozni, használni és sugározni, és ha nincs az utasításoknak megfelelően felszerelve és használva, káros interferenciát okozhat a rádióvétellel. Mindezek ellenére, semmilyen garancia nincs arra, hogy nem keletkezik vételzavar egy bizonyos beszerelés keretén belül. Ha ez a berendezés káros interferenciát okoz a rádió vagy televíziós vételben, melyet az eszköz ki- és bekapcsolása idézhet elő, arra buzdítjuk a felhasználót, hogy az alábbi egy vagy több intézkedés révén próbálja meg javítani az interferenciát:

- a vevőantenna átirányításával vagy átállításával;
- növelje a berendezés és a vevőkészülék közti távolságot;
- a terméket ne csatlakoztassa a vevőkészülékkel azonos áramkörhöz tartozó csatlakozóaljzathoz;
- segítségért forduljon a forgalmazóhoz vagy egy rádió/tévé szakemberhez.

A vállalat nem vállal felelősséget az internet, vezeték nélküli routerek vagy intelligens eszközök által okozott problémákért és meghibásodásokért. További segítségért forduljon a megfelelő szolgáltatóhoz.



A hulladékok környezetfelelős eltávolítása

Segíthet a környezet védelmében!

Kérjük, tartsa be a helyi rendelkezéseket: a nem működő elektromos berendezéseket a használt elektromos hulladékokat gyűjtő központba szolgáltatassa be.



A HEINNER a Network One Distribution SRL(KFT) társaság által bejegyzett védjegy. A többi márkajelzés és a termékek megnevezése kereskedelmi vagy az illető birtoklók által bejegyzett márkanevek.

A leírtak egyetlen része sem használható fel semmilyen formában, még lefordított, átalakított változatban sem, a NETWORK ONE DISTRIBUTION előzetes beleegyezése nélkül.

Copyright © 2013 Network One Distribution. Minden jog fenntartva.

www.heinner.com, <http://www.nod.ro>



A terméket az Európai Közösség előírásainak és jogszabályainak megfelelően tervezték és gyártották.

Importőr: **Network One Distribution**

Marcel Iancu utca, 3-5 szám, Bukarest (București),
Románia

Tel: +40 21 211 18 56, www.heinner.com, www.nod.ro